

*Journal of the
American Musical
Instrument Society*

VOLUME V-VI • 1979-80



Copyright by the [American Musical Instrument Society](#).
Content may be used in accordance with the principles of fair
use under [Section 107 of the United States Copyright Act](#).
Content may not be reproduced for commercial purposes.

Nineteenth-Century Innovations in the Use and Construction of the Timpani

EDMUND A. BOWLES

TECHNOLOGY not only creates new things but enables one to use old devices in new and better ways. Musical instruments are typical cases in point, and this is especially apparent in the evolution of the timpani during the nineteenth century. This was a time when the use of three or more drums of varying sizes and the introduction of so-called machine or rapid tuning revolutionized the way in which these instruments were used.

During this period a major change took place in orchestral texture and sound as composers expressed themselves by means of a vastly expanded musical palette. All sorts of orchestral timbres were combined and contrasted, various modulations from key to key became commonplace, and every instrument was exploited to its very limits.¹

I would like to express my thanks to Professors James Blades, Royal Academy of Music (London) and Richard Hochrainer, Hochschule für Musik (Vienna), as well as to Mr. Jeremy Montagu, Fellowship of Makers and Restorers of Historic Instruments, who read a draft of this paper and offered helpful suggestions.

1. By the early nineteenth century it was customary to write for pairs of flutes, clarinets, oboes, and bassoons, as well as for horns and trumpets. Hence, the number of strings in the orchestra had to be increased in order to maintain a proper balance. The result was an approximate doubling in size. During the course of the next thirty years or so another pair of horns, three trombones, an ophicleide, and more percussion were added to the orchestra. Again, the strings had to be augmented to a total of forty or fifty players. The growth of such orchestras was also stimulated by increasing numbers of performances for a music-hungry public, taking place not at court but in large concert halls. See Adam von A. Carse, *The Orchestra from Beethoven to Berlioz* (Cambridge: W. Heffer, 1948), p. 21. In the Breitkopf thematic catalog, only two symphonies before 1778 and roughly half of those after 1780 called for timpani in their instrumentation (Rey M. Longyear, "Percussion in Breitkopf's Thematic Catalog, 1762-1878," *Percussionist* 6 [1969]: 3). As time went on, more and more of these works required

Obviously, this created a new demand for better, more reliable instruments capable of producing flexibly the softest pianissimo as well as the loudest crescendo in an extended range and in a variety of tone colors. Thus, there developed an upsurge of instrument building in the first several decades of the century as well as corresponding improvements in the instruments then in use designed to meet the more exacting demands of composers and performers alike. Indeed, the period from ca. 1810 to 1880 was an era of vitality, innovation, and change in the manufacture of instruments corresponding somewhat belatedly to the Industrial Revolution.

For example, the pianoforte was invented as a replacement for the harpsichord, which was incapable of expressing gradations in tone color or changes in dynamics. The harp had already evolved from a mainly diatonic instrument to a fully chromatic one supplied with seven pedals capable of raising or lowering all the notes in its scale. In order to correct intonation, provide more power, and eliminate complex or awkward cross-fingering, Boehm introduced a flute fabricated out of metal, cylindrically bored, and furnished with a full arrangement of keys. Similarly, both horns and trumpets were fitted out with valves that liberated them from the confines of their natural harmonic series, made tone production more reliable, and, in the case of the former, eliminated the need for constantly changing crooks to alter the basic pitch and scale of the instrument.

Some of the most radical alterations took place in the use and construction of the timpani. Several problems confronted the composer and performer in this regard. Ignoring special festive performances in which the drums were doubled or even tripled, their number in the orchestra had been limited to a pair, and, until Beethoven, composers usually called for tuning in perfect fourths or fifths. To nineteenth-century composers this soon proved to be unduly restrictive, and they soon added other notes and even changes in the

retuning the drums to a different key for successive movements. Of the 138 orchestras maintained as regular organizations during the first half of the nineteenth century, 116 included percussion instruments as regular constituents of their complement. This represented a fifty percent increase compared to the previous century (Edward B. Gangware, "The History and Use of Percussion Instruments in Orchestration" [Ph.D. diss., Northwestern University, 1962], p. 173).

tuning within their works. Another difficulty was that with the more or less standard size of timpani then in use, the lowest practical note (*F*) often rumbled, owing to the slackness of the skin, while very high notes (*f sharp* and *g*) were difficult and sometimes impossible to reach, especially in humid weather. Furthermore, the clumsy hand tuning by means of a key applied in succession to each square-topped tensioning bolt or by tiny thumb screws was noisy in the former instance, and both time-consuming and extremely difficult to accomplish with precision in a short space of time.² All these factors tended to constrain composer and performer alike. To the former, they limited the demands he could make on the latter, such as the number and variety of different notes for which he could write. To the latter, they presented challenges that were difficult to meet with existing equipment.

The two solutions to these problems, developed over some seventy years, consisted of adding one or two drums of varying sizes to the conventional pair—in other words, extending the instrument's scale or range—and inventing a mechanical device that quickly changed the pitch.

Reacting against what came to be seen as an arbitrary limitation, composers, teachers, and critics alike began calling for the addition of a drum to the standard pair. For example, Gottfried Weber complained that the instrument was both “awkward and incomplete,” with acoustical, musical, and mechanical inadequacies. He wrote that with only two drums the composer was often at a disadvantage

2. Until the late eighteenth century, all kettledrums had to be tuned by removable keys. Around 1790 a French maker of military band instruments named Rolles apparently first invented the T handle that replaced each square-topped tensioning bolt. See François Fétis, “Nouvelles timbales,” *Revue et gazette musicale de Paris* 3 (1836): 370. This represented a considerable step forward: “Any review of the principal changes which have taken place during the nineteenth century in the chief orchestral instruments would be incomplete without some reference to . . . the drums, in which considerable improvements have been introduced. . . . [They] can now, by means of handles acting on the ring enclosing the parchment, be tuned by two or even one handle in the most rapid way, thus enabling them to be played in many more keys than the old system of tonic and dominant tuning allowed.” (W. Barclay Squire, in the *Official Catalog of the International Inventions Exhibition* [London: W. Cloves and Sons Ltd., 1885], p. 309f.)

just when he needed an additional note, and that this situation could be remedied by means of a third or even a fourth kettle, adding, however, that this was not always easy to obtain.³ An anonymous writer decried the limited tonal range of a pair of timpani usually tuned to the tonic and dominant or subdominant, saying that this range could be extended only by the addition of a third drum. He compared two timpani to a stutterer or a person who had to stop talking in mid-sentence for want of the proper word.⁴ The critic Castil-Blaze asked rhetorically, "Why couldn't one seek to increase [the number of drums] in a vast improvement and establish their relationship to all sorts of modulations by providing one more note? This could be accomplished by placing a third kettle in front of the timpanist."⁵ Fétis mentioned the inconvenience of having only two timpani "almost always tuned to the tonic and dominant of the composition they are to perform."⁶ Hector Berlioz said that composers had long complained of the annoying limitation they faced "for want of a third note from the timpani . . . , [but] they never asked themselves whether a single drummer might not play upon three drums."⁷ The composer-theorist Georges Kastner wrote that it would be very desirable to add a third or even a fourth drum to the orchestra, suggesting that if this were done composers would no longer be under such constraints as they found themselves at present.⁸ Obviously,

3. Gottfried Weber, "Vorschlag zu einer Vereinfachung und Bereicherung der Pauken," *Allgemeine musikalische Zeitung* 14 (1814): col. 538f.

4. Anon., "Drey Pauken," *Allgemeine musikalische Zeitung* 28 (1826): col. 349f.

5. François Castil-Blaze, *Dictionnaire de musique moderne de Monsieur Castil-Blaze* (Brussels: Académie de Musique, 1828), p. 252.

6. Fétis, "Nouvelles timbales," p. 369.

7. Hector Berlioz, *Grand traité d'instrumentation et d'orchestration moderne* (Paris: Schoenberger, 1843), p. 253f. Elsewhere, Berlioz writes that "starting with Rossini's arrival at the opera, the instrumental revolution of the theater orchestras was accomplished. The huge noises were employed whatever the occasion in all the musical works, regardless of the style required by the subject. Soon the timpani, bass drum, cymbals, and triangle no longer sufficed, and to them were added another kettledrum, then two cornets came to the aid of the trumpets, the trombones, and the ophicleide." (Hector Berlioz, *A travers chants, études musicales* [Paris: Michel Lévy Frères, 1862], p. 126.)

8. Georges Kastner, *Méthode complète et raisonné de timballes* (Paris: M. Schlesinger, 1845), p. 70. Even some thirty years later Hugo Riemann wrote that "it is to be wished that all larger orchestras would acquire three timpani," suggesting that such a

TABLE 1
Early Examples of Music for Three and Four Timpani

Year	Composer	Work	Tuning
1803	Vogler	<i>Samori</i> , Overture	d, c, G
1807	Weber	<i>Peter Schmoll</i> , Overture	f, e flat, B flat
1809	Weber	<i>Turandot</i> , Incidental Music	d, A, G
1810	Vogler	<i>Die Scala</i>	c, B, A, G
1812	Spohr	<i>Das jüngste Gericht</i>	d, c, G
1815	Reicha	<i>Die Harmonie der Sphären</i>	4 players, 8 drums
1826	Mendelssohn	<i>Trompeten-Ouvertüre</i>	e, c, G
1828	Auber	<i>Masaniello</i> , Overture	d, A, G
1828	Lachner	Symphony no. 1 in E flat	e flat, B flat, F
1830	Auber	<i>Fra Diavolo</i> , Overture	e, d, A
1830	Berlioz	<i>Symphonie fantastique</i>	2 players, 4 drums*
1831	Meyerbeer	<i>Robert le Diable</i>	e, d, c, G*
1831	Bellini	<i>Norma</i>	g, d, G*
1833	Spohr	<i>Calvary</i>	2 players, 6 drums*
1834	Lachner	Symphony no. 3 in D Minor	d, a, F*
1836	Mendelssohn	<i>St. Paul</i>	d, B flat, F*
1837	Berlioz	<i>Requiem</i> Mass	10 players, 16 drums*
1837	Lachner	Symphony no. 6 in D	d, A, F sharp*
1839	Berlioz	<i>Romeo and Juliet</i>	2 players, 4 drums*
1840	Spohr	<i>Historische Symphonie</i>	e flat, d, G
1841	Glinka	<i>Russlan and Ludmilla</i>	g, d, A*
1841	Schumann	Symphony no. 1 in B flat	B flat, G flat, F*
1848	Liszt	<i>Les Préludes</i>	e, c, G*
1849	Meyerbeer	<i>Le Prophète</i>	e, d, c, G*

* Tuning varies throughout the work or movement.

then, everyone was well aware of the problem and what to do about it.

During the first half of the nineteenth century, a number of composers of orchestral music and operas either wrote music requiring three or four timpani (table 1) or included rapid changes of pitch which, with only hand-tuning drums available, demanded an extra instrument pretuned to that unexpected note.⁹ It is of course futile to argue that these new musical requirements alone prompted the new technology, or that in all cases mechanical innovation led these musicians to become more innovative. Organological developments, after all, usually proceed hand-in-hand with contemporary musical evolution. However, one can at least attempt to place these developments in their proper chronological perspective and suggest those factors that influenced both composers and instrument builders.

It has traditionally been claimed that Carl Maria von Weber was the first composer to introduce three drums into the symphony orchestra in the overture to his opera *Peter Schmoll und seine Nachbarn* (1801).¹⁰ However, the assumption is incorrect, and credit for this

condition was the exception rather than the rule (*Musik-Lexikon* [Leipzig: Verlag des Biographischen Instituts, 1882], p. 683).

9. There were, however, some important antecedents that should be mentioned. Among the special categories of polychoral liturgical and outdoor carrousel music written during the Baroque era for two pairs of kettledrums were works by composers such as Biber and Stölzel and the brothers Philidor, respectively. A representative inventory is provided in Edmund A. Bowles, "On Using the Proper Tympani in the Performance of Baroque Music," this *Journal* 2 (1976): 56, fn. 1. In addition, there were a number of so-called chamber works requiring three or more drums, all dating from the eighteenth century: Christoph Graupner's *Sinfonia a 2 corni, 6 timpani, 2 violini, viola e cembalo* (1749); Johann Molter's *Sinfonia per 5 timpani, 2 flauti, 2 violini, violetta e cembalo* (ca. 1750); Johann Hertel's *Sinfonia für VIII tympani obligato* (ca. 1767); and Mozart's *Divertimento* no. 6 (K.188) for 2 flutes, 5 trumpets, and 4 timpani (1776). However, these were all *pièces d'occasion*, obviously not composed with a symphony orchestra in mind. Other exceptions to the standard repertory included Antonio Salieri's opera *La secchia rapita* (1772), scored for three drums, Johann Reichardt's cantata *Cantus lugubri in obitum Friderici Magni* (1787) and *Schlachtsinfonie* (ca. 1790), both calling for four timpani, Antonio Sacchini's overture to the opera *Oedipe à Colone* (1786), and Ferdinand Kauer's *Sei variazioni* (ca. 1810), with six drums featured in a variation displaying considerable virtuosity.

10. Taken more or less at random, a few of the more modern sources are Percival A. Kirby, *History of the Kettle-Drums* (Oxford: Oxford University Press, 1930), p. 16; Percy A. Scholes, *The Oxford Companion to Music*, 2d ed. (London/New York:



EXAMPLE 2. Carl Maria von Weber, *Peter Schmoll* (1807), Overture.

Schmoll (the basis for the opera's single unsuccessful performance in Augsburg in 1802) the instrumentation calls for flute, oboe, horn, trumpets and timpani in pairs, and the usual strings. In the following year Weber travelled to Vienna, apprenticing himself to Vogler, who, according to various contemporaries, exerted more of an influence upon the young composer than any other musician. It is interesting to note that Weber prepared the vocal score to *Samori* and helped with the opera's rehearsals as well. Four years later he salvaged the overture to his own *Peter Schmoll* and published it under opus 8 as a separate work entitled *Grande ouverture à plusieurs instruments*. In his revised orchestration Weber added two clarinets, a trombone, and a third drum (ex. 2).¹³ It seems obvious that Weber had been influenced by his teacher, who provided a dramatic new example of how to write for the timpani.¹⁴ Subsequently, in both his incidental music for *Turandot* (1809) and overture to *The Ruler of the Spirits* (1811) he employed three drums again.

As both teachers and composers, Vogler and his contemporary Anton Reicha were common sources of inspiration during this early period. Reicha spent the years 1802 to 1808 in Vienna, then settled in Paris, where he became naturalized in 1829 and counted both Berlioz and Liszt among his many students. His choral ode *Die Harmonie der Sphären* ("Horch wie orgelt, wie braust die Aeolsharfe der Schöpfung!") called for four timpanists, each playing a pair of drums, as well as for the use of rolled chords to support the chorus (ex. 3). The music duly impressed young Berlioz, serving no doubt as a model for

13. See Friedrich W. Jähns, *Carl Maria von Weber in seinen Werken* (Berlin: Schlesinger'sche Buch- und Musik Handlung, 1871), pp. 38, 43, and 69.

14. Berlioz, in praising Weber's orchestration and alluding to his musical heritage, wrote "O Weber; that is, Carl Maria von Weber in the tradition of Vogler!" (Schafhäütl, *Abt Georg Vogler*, p. 214). On Weber's orchestration, see Alfred Sandt, "Karl Maria von Webers Opern in ihrer Instrumentation" (Ph.D. diss., Frankfurt-am-Main, 1921).

Allegro

EXAMPLE 3. Anton Reicha, *Die Harmonie der Sphären* (1815).

the latter's *Symphonie fantastique* and *Requiem* in particular.¹⁵ Fore-shadowing his famous pupil, Reicha argued in print for an ideal orchestra with masses of strings (114), a dozen woodwinds each, twelve horns, six trumpets, six trombones, and six timpani tuned in such a way as to provide all the possible harmonies.¹⁶

Special mention must be made of both Meyerbeer and Berlioz, the pupils of Vogler and Reicha respectively. Meyerbeer, too, had spent some time both in Darmstadt with Vogler and in Vienna before settling permanently in Paris in 1826, where he lived and worked for thirty-eight years except for a brief period in Berlin. Meyerbeer's pivotal role in the history of romantic opera is too well known to require repetition here. He enlarged the opera orchestra in terms of both varieties of instruments (cornet, ophicleide, saxhorn) and their quantity. Suffice it to say that in his trend-setting and widely popular opera *Robert le Diable* (1831) he wrote for four timpani in a manner far more elaborate and demanding than most of his contemporaries (ex. 4).¹⁷ Indeed, Meyerbeer considered this to be his own innova-

15. See Maurice Emmanuel, *Anton Reicha* (Paris: H. Laurens, 1937), p. 53. The piece is often erroneously referred to as the *Ode to Schiller*, in spite of the fact that the text was taken from a poem by Ludwig Kosegarten.

16. Anton Reicha, *Traité de haute composition musicale*, 2 (Paris: Richault, 1826), p. 330.

17. Meyerbeer's orchestration in general is discussed in Gabriel Pierné and Henry Woollett, "Histoire d'orchestration," in the *Encyclopédie de la musique et dictionnaire du Conservatoire*, part 2, vol. 4 (Paris: C. Delagrave, 1929), pp. 2511-30; Henri Lavoix, *Histoire de l'instrumentation depuis le seizième siècle jusqu'à nos jours* (Paris:

Moderato



EXAMPLE 4. Giacomo Meyerbeer, *Robert le Diable* (1831).

tion. Speaking of his new work, he wrote in his diary on 25 January 1831, "But now [Louis Josef] Hérold, as choral director, can go to the opera every day . . . , read my score, and if he likes may utilize my new instrumental effects; for example, four timpani."¹⁸ In any case, the part must have been a challenge to the drummer, Charles Poussard. A note in the composer's pocket calendar for 15 November mentions the thirteenth orchestral rehearsal with the double-basses and timpani.¹⁹ When the score was first published by Schlesinger in Berlin, the editor reduced the four drums to three and in the final chorus to act 4 (no. 17) had the low strings play the fourth note pizzicato, so as to limit the number of timpani required to what an orchestra in a crowded pit could reasonably be expected to provide.²⁰

Firmin-Didot et Cie, 1878), pp. 386–416; and Fritz Volbach, *Das moderne Orchester*, 2d ed. (Leipzig/Berlin: B. G. Teubner, 1919), p. 86ff. On the instrumentation of *Robert le Diable*, see Julius Kapp, *Giacomo Meyerbeer*, 8th ed. (Berlin: Schuster und Loeffler, 1932), pp. 169–76.

18. Giacomo Meyerbeer, *Briefwechsel und Tagebücher*, ed. Heinz Becker (Berlin: W. de Gruyter, 1970), vol. 2, p. 121.

19. *Ibid.*, p. 152. Meyerbeer received his baptism in percussion as a young man. Along with Hummel, Moscheles, and other leading musicians of Vienna, he was recruited to play in a performance of Beethoven's *Wellington's Victory or the Battle of Vittoria* (op. 9) in 1813. In the master's own words, "I became acquainted with [Meyerbeer] at the performance of my Battle [Symphony], on which occasion a number of local composers played various instruments. The bass drum was assigned to Meyerbeer. Ha! ha! ha! I was not at all satisfied with him; he struck the drum badly and was always late, so that I had to give him a good dressing down." (Alexander W. Thayer, *Ludwig van Beethovens Leben* [Leipzig: Breitkopf und Härtel, 1907–17], vol. 3, p. 452, note 2.) A similar English translation is given in Thayer's *Life of Beethoven*, rev. and ed. Elliot Forbes (Princeton: Princeton University Press, 1964), vol. 2, p. 598. In album notes to a Deutsche Grammophon recording of this work (no. 139045), Joseph Schmidt-Görg claims that Meyerbeer played the timpani, but this cannot be substantiated.

20. Apparently, only the largest opera houses had room in their pits for four drums, because several contemporary sources take pains to point out how to make do with two or three timpani. See for example Ernst G. B. Pfundt, *Die Pauken* (Leipzig:

Conspicuous among these pioneer innovative composers for the timpani was Hector Berlioz. Ever observant, he learned much from his professional attendance at concerts as a critic and was tremendously impressed with the orchestral effects in *Robert le Diable*. He took special note of the well-known passage cited above, commenting upon the beats of double-bass and timpani employed melodically together.²¹ Reviewing a performance of *Les Huguenots* a year later, Berlioz mentioned the double roll for two timpanists, with crescendo and decrescendo, during the massacre scene.²² In his treatise on instrumentation—long the standard textbook on the subject—Berlioz argued that requiring two players, each provided with a pair of drums, allowed for a greater selection of notes.²³ Also, while one timpanist was playing, the other could be retuning his instruments, or both could perform together, sometimes with the addition of a third or fourth drummer, to produce actual chords.

Berlioz carried out his theory into practice; his *Symphonie fantastique*, *Romeo and Juliet*, and *Damnation of Faust* each require two pairs of drums throughout. Reviewing the first performance of the *Symphonie fantastique*, one critic noted that “the instrumentation is grandiose and written in a very original manner,” later commenting upon the “grotesque instrumental effects” in the last movement.²⁴

Breitkopf und Härtel, 1849), p. 19. Once machine drums were generally available, even the smaller orchestras could make do after a little readjusting of the timpani parts and by omitting some of the notes. Concerning the example cited above, “since in our theater orchestras there are rarely more than two drums . . . only the [first two-measure] figure is played by the timpani, the rest by the pizzicato of cellos and basses. Skilled timpanists who have machine drums at their disposal beat three notes upon two timpani, quickly changing *c* to *d*.” (Ferdinand Gleich, *Die Hauptformen der Musik* [Leipzig: C. F. Kahnt, 1862], p. 73.) Pfundt (*Die Pauken*, p. 19), says that the timpanist can play all the notes with one hand while changing the pitch of the high drum with the other (i.e., by turning the crank).

21. Hector Berlioz, “De l’instrumentation de Robert le Diable,” *Revue et gazette musicale de Paris* 2 (1835): 131.

22. Hector Berlioz, “Les Huguenots (première représentation),” *Revue et gazette musicale de Paris* 3 (1836): 77.

23. Berlioz, *Grand traité*, p. 262. On the composer’s use of timpani in general, see Eduard Bernoulli, *Hector Berlioz als Ästhetiker der Klangfarben* (Zürich: Hug & Co., 1909), p. 25.

24. Johann Mainzer, “Paris im Januar 1837,” *Cäcilia* 19 (1837): 128. Here, too, Berlioz required the second timpanist to change *c sharp* back to *c* in less than a minute

Animato

The image shows ten staves of music for timpani, arranged in two groups of five. Each staff is in 4/4 time and begins with a treble clef. The tempo is marked 'Animato'. The first measure of each staff contains a single note with a dynamic marking of *f*. The second measure contains a single note with a dynamic marking of *ff*. The third measure contains a single note with a dynamic marking of *ff*. The fourth measure contains a single note with a dynamic marking of *ff*. The fifth measure contains a single note with a dynamic marking of *ff*. The sixth measure contains a single note with a dynamic marking of *ff*. The seventh measure contains a single note with a dynamic marking of *ff*. The eighth measure contains a single note with a dynamic marking of *ff*. The ninth measure contains a single note with a dynamic marking of *ff*. The tenth measure contains a single note with a dynamic marking of *ff*. Each staff ends with a fermata and the number 12.

EXAMPLE 5. Hector Berlioz, *Requiem* Mass (1837).

The *Requiem* presented problems right from the start. In the autograph manuscript Berlioz had called for no less than thirty-two timpani to be played by twenty drummers, but he realized the impracticality of this requirement and compromised in the published score by asking for only ten players on sixteen drums (ex. 5).²⁵ However, for the premiere he had to reduce the participation still further to three timpanists, rearranging the parts accordingly.²⁶

and *G sharp* to *G* in barely half that time. Together with the *Waverly Overture* (1828), this seems to have been the first example in symphonic literature of a change required during the actual playing of a movement. Antonio Salieri is credited with having introduced a change during a tacet period of an opera in his *La grotta di Tronfonio* (ca. 1785). Weber did the same in both *Abu Hassan* (1810) and *Der Freischütz* (1821).

25. See for example Hector Berlioz, *Werke*, ed. Charles Malherbe and Felix Weingartner (Leipzig: Breitkopf und Härtel, 1900-07), vol. 7.

26. Alban Voigt, "Zur Geschichte der Pauken," *Zeitschrift für Instrumentenbau* 52 (1931-32): 426. I recall a performance by the Boston Symphony Orchestra under Charles Munch in 1951 with four timpani played by one performer and a pair each by two others.

Allegro

tr *pp* *p* *poco a poco cresc.*

B *tr* *ff* *tr* *tr* *tr* *tr* *tr* *tr*

EXAMPLE 6. Ludwig Spohr, *Calvary* (1833).

Berlioz also listened to orchestras generally and timpanists in particular with an extremely critical ear. He placed the Parisian manner of playing drums above the German; and according to his opinion there were in the whole of Europe not three good timpanists! Unfortunately, his favorites are never identified.²⁷ Speaking of the drummer in the court opera orchestra in Berlin, for example, Berlioz wrote that he “is a good musician, but his wrists are not supple nor his rolls sufficiently rapid, his kettledrums also are too small and have too little tone, and he is acquainted with only one sort of drumstick.”²⁸ Berlioz blamed the generally low state of playing on his fellow composers, most of whom, he claimed, made but pedestrian use of the drums to mark accented beats in a measure. This meant that the percussionist could get by without being either a real musician or an expert on his instrument.²⁹

Ludwig Spohr visited Leipzig, Dresden, Prague, Munich, Paris, and London in 1807. Five years later he became conductor of the orchestra at the Theater an der Wien in Vienna, and from 1822 until his death he remained in Kassel as *Hofkapellmeister* to the Elector of Hesse. His oratorio *Calvary* (1833) includes a section in which an earthquake at the time of the Crucifixion is represented by double

27. *Mémoires de Berlioz* (Paris: Michel Lévy Frères, 1870), vol. 2, p. 211.

28. *Memoirs of Hector Berlioz from 1803 to 1865*, trans. Rachel S. Holmes and Eleanor Holmes (New York: A. A. Knopf, 1932), p. 309.

29. *Ibid.*, p. 406.

Scherzo

EXAMPLE 7. Ludwig Spohr, *Historical Symphony* (1839), third movement.

rolls played by two timpanists, each outfitted with three drums (ex. 6). In his *Historical Symphony*, the first movement (“1720”) uses the orchestra of Bach and Handel, with strings and flutes, oboes, bassoons, and horns in pairs. The second movement (“1780”) is in the style of Haydn and Mozart; two clarinets are added. The third movement (“1810”) is written for an orchestra of the Beethoven period, significantly adding three timpani (ex. 7). The final movement (“1840”), representing the modern era, includes piccolo, three trombones, four horns, trumpets, and percussion.

A composer influenced by Spohr, Mendelssohn, and Meyerbeer was Franz Lachner, whose talents included those of organist, music teacher, cellist, horn player, and performer on the double-bass. He was conductor at the Kärntnertheater in Vienna for nine years before assuming the post of *Kapellmeister* at the Munich court chapel and royal opera in 1836, where he remained for almost thirty years. In his symphonies and orchestral suites Lachner frequently called for three timpani and sometimes even required the performer to change the pitch of a drum during a movement.³⁰ For example, the solo passage in the third movement of his *Symphony no. 3 in D Minor*, a

30. See Max Chopp, *Zeitgenössische Tondichter* (Leipzig: Druck und Verlag der Rosberg'schen Buchhandlung, 1890), pp. 70–73; and Otto Kronseder, “Franz Lachner” (Ph.D. diss., Leipzig, 1903), esp. pp. 10–31. Benvenaga (see fn. 83) points out (p. 57f.) that in Lachner’s operas written after the orchestra’s acquisition of the August Knocke type of machine drums from the Kaltenecker firm in 1841 (see below), only two timpani were indicated, the additional notes being played by means of rapid tuning.

Andante con moto quasi allegretto

pp

ff

pp cresc.

ff

EXAMPLE 8. Franz Lachner, *Symphony no. 3 in D Minor* (1834), third movement.

rhythmic figure repeated throughout, is equal in complexity to anything Meyerbeer was writing at the same time (ex. 8).

As an adolescent prodigy in Paris, Franz Liszt had heard the music of the leading composers of the day. He was especially impressed by the *Symphonie fantastique* and *Damnation of Faust*.³¹ Liszt lived in Weimar for thirteen years at a later period, during which over twenty operas by living composers were staged; and to the house he shared with the Princess Carolyne von Sayn-Wittgenstein came many of the most important musicians of Europe. Throughout his career he composed both symphonic poems and large works for chorus and orchestra requiring three or four timpani, following the lead of his contemporaries.³² While his writing for timpani is not particularly innovative, it does demand a good tuning technique on the performer's part. The third movement of Liszt's *Faust Symphony* ("Mephistopheles")—dedicated, by the way, to Berlioz—is perhaps the best case in point. Here, too, the quick pitch changes required in less than a measure (for example, *c* to *c sharp*) suggest that the composer must have assumed either the presence of four drums in the orchestra (unlikely except in major ensembles) or the availability of some type of machine tuning (ex. 9). Those composers whose works influenced Liszt most can be seen from a letter he wrote following a performance of his symphonic poem *Tasso* in 1861: "In my orchestral works, I have accepted the higher standard of instrumentation (Paris, Vienna,

31. Charles Laforêt [Flavien Bonnet-Roy], *La vie musicale au temps romantique* (Paris: J. Peyronnet et Cie, 1929), p. 145.

32. On Liszt's use of timpani, see for example Joseph Weber, "Die symphonischen Dichtungen Franz Liszts" (Ph.D. diss., Vienna, 1929), p. 75.

Allegro vivace

Allegro non troppo

EXAMPLE 9. Franz Liszt, *Faust* Symphony (1857), third movement.

Berlin, Dresden)—or, if you prefer names of persons, Meyerbeer, Mendelssohn, Wagner, Berlioz.”³³

With Richard Wagner the primacy in innovative orchestral writing shifted to Germany. In the *Ring of the Niebelung* (1853–74) the timpani came into their own as solo instruments, underlining the emotion or drama of the text. Liberated from their conventional tie with the brasses and from the old tonic/dominant syndrome, the drums were used by Wagner both coloristically and symbolically, rather than merely rhythmically (ex. 10). Following the example of Berlioz, whose music he admired, Wagner employed two pairs of timpani, often simultaneously, throughout the four operas in his *Ring* cycle, thus providing far greater latitude as far as scoring is concerned. Emulating Meyerbeer, he used rolls for dramatic effects and both rhythmic and melodic figures on the drums as *Leitmotivus*.³⁴

33. Franz Liszt, *Briefe*, ed. La Mara, vol. 1 (Leipzig: Breitkopf und Härtel, 1893), p. 386. In one of his essays the composer singled out Meyerbeer's operas and their orchestration for special comment. See *Gesammelte Schriften von Franz Liszt*, ed. La Mara, vol. 2 (Leipzig: Breitkopf und Härtel, 1910), pp. 138 and 141.

34. See Egon Voss, *Studien zur Instrumentation Richard Wagners* (Regensburg: G. Bosse, 1970), p. 221f. In *Parsifal*, for example, the composer called for a low E, presupposing the availability by that time of a large kettle approximately 28 to 30

major cultural centers.³⁵ It was within this fertile environment that the use and construction of the timpani were exploited. Any discussion of specific influential instrumental ensembles in this regard must properly begin with the court orchestra in Mannheim, which boasted an unrivalled concentration of talented musicians.³⁶ Its collective virtuosity, precision, phrasing, and expressive musical and dynamic effects were renowned; and long before this period travelers and musicians alike were full of praise for both the quality of orchestral playing and the style of conducting there, particularly under Christian Cannabich's direction.³⁷ Significantly, Mannheim possessed two pairs of drums as far back as 1720, and the composers of the so-called Mannheim School such as Karl Stamitz and Anton Filtz used drums in many of their symphonies.³⁸

One of the musical families that flowered during and after the Mannheim period was the Cramers.³⁹ Jacob Cramer (1705–1777), a composer and member of the violin section since 1757, was men-

35. See Heinz Becker, *History of Instrumentation*, trans. Robert Kolben (Cologne: Arno Volk Verlag H. Gerig, 1964), p. 25: "In the larger cities, the orchestras were now placed on a secure and regular basis, which meant that composers could be objective in their instrumentation without having to consider the special abilities or failings of certain players or instrumental sections. Amateurs were employed less and less, except in the smaller court orchestras. The end of the 18th century had already seen the beginning of the age of specialization among musicians; this had become necessary by the increasing technical demands imposed by modern scores, and finally led to the establishment of the modern conservatorium, first in Paris in 1795, quickly followed by Milan and Naples in 1808, Prague in 1811, and Vienna in 1821, where the instrumental classes concentrated on the pupil's learning one, and only one instrument."

36. On this orchestra during the reign of Archduke Karl Theodor, see *Die Musik in Geschichte und Gegenwart*, vol. 8, cols. 1599–1601; Otto Ursprung, *Münchens musikalische Vergangenheit* (Munich: Bayerland-Verlag, 1927), part 3, esp. p. 183f.; Anton Pichler, *Chronik des grossherzoglichen Hof und Nationaltheaters in Mannheim* (Mannheim: J. Bensheimer, 1879); and Friedrich Walter, *Die Entwicklung des Mannheimer Musik- und Theaterlebens* (Mannheim, 1897).

37. See for example Percy A. Scholes, ed., *Dr. Burney's Musical Tours in Europe*, part 2, *An Eighteenth Century Musical Tour in Central Europe and the Netherlands* (London/New York: Oxford University Press, 1959), vol. 1, p. 34f.

38. Friedrich W. Marpurg, *Historisch-kritische Beyträge zur Aufnahme der Musik* (Berlin: G. A. Lange, 1754–57), vol. 2, p. 567.

39. For a bibliography of the Cramer family, see Felix J. Lipowsky, *Baierisches Musik-Lexikon* (Munich: J. Giel, 1811), pp. 56–58; François Fétis, *Biographie universelle des musiciens*, 2d ed. (Paris: Firmin-Didot Frères, 1875), vol. 2, pp. 384–86 (Gerhard is confused with Johann); and Hugo Riemann, *Musik-Lexikon*, p. 182f.

tioned among the best virtuosi of Europe. His son, Johann, was timpanist of the orchestra, a post he continued to occupy after the court moved to Munich in 1778 when Duke Karl Theodor became Elector of Bavaria.⁴⁰ Johann's son, Gerhard, succeeded his father as court timpanist in 1807, switching from violin for this new post. And the latter's son, Johann, assumed the same position in 1845, performing until 1860. Under its conductor Friedrich Fränzl, the Munich ensemble numbered seventy musicians in all, and seven years later the roster included eighty players, making it one of the largest ensembles of its time.⁴¹

Paris had long been the center of orchestral cultivation, particularly with respect to wind and percussion instruments. The Paris Opera orchestra was considered to be one of the top ensembles in Europe.⁴² Berlioz referred to the institution as that "big theater with its big orchestra."⁴³ He observed that "most of its members being virtuosi of the first rank, they also belong to the Conservatoire's famous orchestra, which keeps them in touch with the art in its purest form." One of the earlier timpanists was Jean-Madeleine Schnitzhoeffer (1785–1852), also a member of the royal chapel orchestra from 1815 to 1825 and later chorus-master of the opera.⁴⁴ His most

40. See for example Friedrich Walter, *Geschichte des Theaters und der Musik am kurpfälzischen Hofe* (Leipzig: Breitkopf und Härtel, 1898), p. 217f.; and Franz M. Rudhart, *Geschichte der Oper am Hofe zu München* (Freising: F. Datterer, 1865), vol. 1, p. 131 et passim.

41. Anon., "Gesammtzustand der königliche Hofmusik in München," *Allgemeine musikalische Zeitung* 12 (1820): col. 550; and Anon., "Königlich-Bayerische Hofkapelle in München," *ibid.* 29 (1827): col. 438f.

42. The orchestra's reputation went back to the days of Lully, who, having obtained a charter from Louis XIV in 1672, carefully selected its members, drilled them, and "achieved a quality of performance which made it celebrated throughout Europe" (Donald J. Grout, *A Short History of Opera* [New York: Columbia University Press, 1947], vol. 1, p. 124). He introduced the timpani into the royal opera orchestra, probably for the performance of his opera *Alceste* in 1673. See Joseph Baggers, "Les timbales, le tambour et les instruments à percussion," in *Encyclopédie de la musique et dictionnaire du Conservatoire*, part 2, vol. 3, p. 1689.

43. Hector Berlioz, *Evenings with the Orchestra*, trans. and ed. Jacques Barzun (New York: A. A. Knopf, 1956), p. 106f.

44. Fétis, *Biographie universelle*, vol. 7, p. 495; and Georges Kastner, *Traité générale d'instrumentation* (Paris: Chez Philippe Cie, 1837), p. 50. See also J. Baggers, "Les timbales," p. 1694; and Antoine Elwart, *Histoire de la Société des Concerts du Conservatoire* (Paris: Lemoine, 1860), p. 101.

famous successor was Charles Poussard (b. 1798), to whom Berlioz gave credit for having introduced the use of three kettledrums into the orchestra.⁴⁵ Speaking about the ensemble in general, one eyewitness said that "Herr Poussard especially is a remarkable artist on his drums."⁴⁶ Spohr wrote in 1820 that the Paris Opera orchestra, as compared with the others in that city, "had the greatest number of famous and distinguished artists."⁴⁷ It is impossible to say exactly in what year three timpani arrived on the scene; but the first performances of Auber's *Masaniello* (1828) and Meyerbeer's *Robert le Diable* (1831), *Les Huguenots* (1836), and *Le Prophète* (1849) took place at the Opera. All of them require three or four drums.⁴⁸

Concerning the "fiery" Paris Conservatory orchestra, Fétis wrote that its concerts were celebrated throughout Europe.⁴⁹ Both this ensemble and the Académie Royale de Musique had three drums by 1845, placing them among the few such orchestras in Europe.⁵⁰ Again, some of Auber's popular operas were premiered by the Opéra Comique; *Fra Diavolo* (1830), for instance, was written for three timpani, so that orchestra, too, must have possessed the requisite number of instruments. The Concert Spirituel ensemble had two

45. Berlioz, *Evenings*, p. 254. Under the rubric "Orchestra" in the personnel records of the Paris Opera are listed the names of all the timpanists from the very beginning to 1900. (These records comprise the AJ¹³ series of documents in the French National Archives.) Poussard's contract with the orchestra (dated 1832, but this may be a renewal) is to be found cataloged under no. AJ¹³ 198, dI, 1059 with a further notice under no. F²¹ 1058. For this information, my thanks to Monsieur F. Doucet, Assistant to the Director of the Archives de France, Ministère de la Culture et de l'Environnement.

46. Anton Schindler, *Beethoven in Paris* (Münster: Aschendorff'sche Buchhandlung, 1842), p. 12.

47. *The Musical Journeys of Ludwig Spohr*, ed. and trans. Henry Pleasants (Norman: University of Oklahoma Press, 1961), p. 229.

48. The first performances of operas in various European cities are listed in chronological order by titles in *Annals of Opera*, comp. Alfred Loewenberg, 3d rev. ed. (Totowa, N.J.: Rowman and Littlefield, 1978). This guide is extremely useful in comparing operas requiring three or four timpani with the various orchestras that performed them.

49. François Fétis, *Curiosités historiques de la musique* (Paris: Janet et Cotelle, 1830), p. 336.

50. Kastner, *Méthode complète*, pp. 26 and 70. On the Conservatoire, see Arthur Dandelot, *La Société des Concerts du Conservatoire de 1828 à 1897* (Paris: G. Havard Fils, 1898), esp. p. 8.

pairs of timpani available.⁵¹ No wonder, then, that visitors to Paris were impressed with these several orchestras and their superb musicians.

The Leipzig Gewandhaus orchestra, established in 1781, became the leading ensemble in Germany under the conductorship of Felix Mendelssohn. Beginning his tenure in 1835, he honed the players into a group without peer.⁵² The composer's own oratorio *St. Paul*, requiring three drums, was performed in 1837.⁵³ Mendelssohn was known particularly for his series of Beethoven concerts. He was both conducting the orchestra and playing the solo part of the *Emperor* Concerto in that same year when, during a rehearsal, he became dissatisfied with the performance of the timpanist, Friedrich Grenser.⁵⁴ The maestro then called upon the services of Ernst Gotthold Pfundt (1806–1871), a piano teacher, choral director, and tenor soloist at the Leipzig Theater.⁵⁵ During subsequent rehearsals, Pfundt executed Mendelssohn's instructions so well that he earned the com-

51. Constant Pierre, *Histoire du Concert Spirituel* (Paris: Imprimerie Nationale, 1875), p. 77.

52. On praise for this orchestra by an American visitor, see Lowell Mason, *Musical Letters from Abroad* (New York: Mason Brothers, 1854), p. 23f.

53. Theodor Müller-Reuter, *Lexikon der deutschen Konzertliteratur* (Leipzig: C. F. Kahnt Nachfolger, 1909), p. 93.

54. Mendelssohn seemed particularly sensitive towards the timpani even outside his own compositions. For example, commenting upon the Paris Conservatory orchestra during a visit to that city in 1832, he observed that the drums had a "hollow, dull sound, like a bass drum" (*Reisebriefe aus den Jahren 1830 bis 1832*, ed. Paul Mendelssohn-Bartholdy [Leipzig: H. Mendelssohn, 1865], p. 342). In a letter to Ignace Moscheles (7 February 1834) he wrote, "Among other things, I am particularly pleased by the mode in which Handel, towards the close, rushes in with his kettledrums and trumpets" (*Letters of Felix Mendelssohn-Bartholdy from 1833 to 1847*, trans. and ed. G. S. Wallace [New York: Leypoldt and Holt, 1868], p. 24). An anecdote concerning a rehearsal of Mendelssohn's Overture to *A Midsummer Night's Dream* in 1832 relates that "when we were ready to begin, it was found that the timpanist's chair was empty. To [our] general amusement, Mendelssohn jumped into the orchestra, seized the sticks, and rolled like an old veteran" (Ferdinand Hiller, *Felix Mendelssohn-Bartholdy: Briefe und Erinnerungen* [Cologne: Verlag der M. DuMont-Schaubert'schen Buchhandlung, 1874], p. 18).

55. Pfundt's biography can be found, for example, in *Julius Schuberths musikalisches Conversations-Lexikon*, ed. Robert Músiol (Leipzig: J. Schuberth & Co., 1877), p. 345; and Riemann, *Musik-Lexikon*, p. 696.

Scherzo

8 *tr* *ff*

15 *tr* *f*

tr *ff*

EXAMPLE 11. Robert Schumann, Symphony no. 1 in B flat (1841), second movement.

poser's everlasting approval, so much so that shortly thereafter he was engaged as solo timpanist of the orchestra.

Pfundt became known subsequently as an expert without peer, the first timpanist in all of Germany.⁵⁶ He was a nephew of Friedrich Wieck, Clara Schumann's father, a fact which might explain in part Schumann's own characteristic use of the drums in terms of family osmosis!⁵⁷ At the very least, this is one of the first examples of the close interaction between composer and timpanist that resulted in some trendsetting music for the instrument.⁵⁸ Schumann's well-known Symphony no. 1 in B flat ("Spring") was the first popular work in that genre to require three drums, its third movement containing a particularly demanding part for this early period (ex. 11). Shortly after its premiere by the Leipzig orchestra on 31 March 1841 (during Pfundt's temporary absence), Schumann wrote that Pfundt "was a veritable hero upon his instrument, who stands in relation to the present performer [Grenser, again] and to others as genius does to

56. See Alfred Dörffel, *Geschichte der Gewandhausconcerte zu Leipzig* (Leipzig: Breitkopf und Härtel, 1884), esp. p. 90.

57. While he required only three drums in the Symphony no. 1 in B flat (1841), the composer demanded several changes of pitch in the first movement of his Symphony no. 4 in D Minor. Since Pfundt was known to have used machine drums (see below), it is interesting to speculate whether or not this relationship might have influenced Schumann in requiring what then represented a radical departure from tradition.

58. On Schumann's orchestration, see Otto Karsten, "Die Instrumentation R. Schumanns" (Ph.D. diss., Vienna, 1922), p. 47ff.

mere talent. His roll in the B-flat Symphony, several places in Mendelssohn's overtures, etc., is a masterpiece difficult to equal; it can scarcely be heard in the orchestras of Paris or New York."⁵⁹ In another context reviewing Leipzig's musical activities, Schumann said that a special place should be reserved for Ernst Pfundt, who was "unexcelled, always ready and present like thunder and lightning; he plays the timpani exactly right."⁶⁰ But this unique individual had other talents: he wrote one of the first timpani manuals and, together with a mechanic, helped to improve the design of a machine drum with single-screw tuning that represented a substantial improvement over Cramer's earlier model and was used throughout Germany.

The Dresden Royal Opera orchestra had employed two timpanists as far back as 1734, although it cannot necessarily be assumed that two pairs of drums were found from then on; indeed, there is evidence that only a pair was in use in the early nineteenth century.⁶¹ Between 1820 and 1840 the orchestra numbered from fifty-three to sixty-one musicians, including Johann Seibecke as timpanist.⁶² In contrast to earlier times, when the players had to furnish their own instruments,

59. Robert Schumann, *Gesammelte Schriften über Musik und Musiker*, 4th ed., ed. F. Gustav Jansen (Leipzig: Breitkopf und Härtel, 1891), vol. 2, p. 301.

60. *Ibid.*, p. 103. One is tempted to surmise that the timpani solo at the very end of the Symphony no. 2 in C was written with Pfundt in mind. Certainly, it is the first example of its kind in symphonic literature. Wagner, too, knew of Pfundt and had visions of luring him to Dresden as second timpanist. In *Die königliche Kapelle betreffend* he writes, "For every instrument there appears from time to time a most singular talent, and on the timpani such [an individual] may be considered in the fullest sense [to be] the young man, *Musicus* Pfund[t] in Leipzig. He handles his instrument so beautifully—[which is] so important for the orchestra—that his highly unique achievements caught our eye repeatedly and finally aroused our wish to acquire this musician for the Royal Orchestra" (*Der junge Wagner: Dichtungen, Aufsätze, Entwürfe* (1832–1849), ed. Julius Kapp (Berlin/Leipzig: Schuster und Loeffler, 1910), p. 386f.

61. See Heinz Becker, "Das neuere Orchester," in *Die Musik in Geschichte und Gegenwart*, vol. 10, table following col. 192, p. iv. On the early history of the orchestra, see Karl Laux, *The Dresden Staatskapelle* (Leipzig: VEB Edition, 1964), esp. pp. 30–62. In discussing the need to purchase new timpani for the Royal Orchestra, Wagner wrote that "it would be not merely desirable but [rather] necessary that three such instruments should be acquired . . . , since in the newer operas it is very often necessary that, owing to the various rapid tuning changes, three kettledrums are [required] together in the pit" (Kapp, ed., *Der junge Wagner*, p. 390).

62. Anon., "Königlich-Sächsische Kapelle in Dresden," *Allgemeine musikalische Zeitung* 25 (1823): col. 317f. See also the *Dresdner Kapellbuch*, ed. Günter Hausswald (Dresden: Dresdner Verlagsgesellschaft, 1948), p. 127ff.

under the conductor Karl Gottlieb Reissiger almost all of the instruments, including drums, were acquired at royal expense.⁶³ Liszt's *Dante* Symphony, for which four timpani were required, was performed on 7 November 1857.⁶⁴

Darmstadt had long been the center for concert and operatic performances of works by an international roster of famous composers. For example, Christoph Graupner, composer of the *Sinfonia* for 2 horns, 6 timpani, and strings (1747) was *Kapellmeister* at the court of Ludwig VIII. The court orchestra flourished particularly under the enlightened patronage of Landgraf Ludwig X (later Archduke Ludwig I), who reigned from 1810 to 1830.⁶⁵ Between 1807 and 1814 the *Kapellmeister* was Georg Vogler, who enlarged the orchestra's personnel in all sections and added more performances in the court theater.⁶⁶ In 1811 Vogler's *Samori* was performed, followed by Sacchini's *Oedipus at Colonus* in 1819, Auber's *Masaniello* in 1829, and Meyerbeer's *Robert le Diable* in 1835.⁶⁷ Thus, the orchestra must have possessed more than two drums by this time; and, as we shall see later on, there is evidence that the first pair of machine

63. Hans von Brescius, *Die Königlich sächsische musikalische Kapelle von Reissiger bis Schuch, 1826–1898* (Dresden: C. C. Meinhold & Söhne, 1898), pp. 32 and 35f.

64. Müller-Reuter, *Lexikon*, vol. 1, p. 274.

65. According to the diary of the court actor Friedrich Porth, rehearsals started promptly at 6:00 P.M. with the orchestra tuned up and the *Kapellmeister* at the keyboard. "After the greetings were over the Archduke approached the conductor's stand, pulled out his baton from under his uniform, gave the upbeat, and the ensemble burst into sound, following their leader willingly in all things. As far as his orchestra was concerned, nothing escaped the Archduke's attention. It was rare that he allowed his baton to rest on the conductor's stand and turned his head towards a singer or the composer. He showed his greatest appreciation when he stepped to the railing [of the podium], stroked his chin with his hand, and spoke to the orchestra: 'Thunderation, by the devil, today things really went [well]!' or 'Thunderation, by the devil, you must really feel very hot, gentlemen. I do, too, but we have to do our duty!' The end of the rehearsal was indicated by the Duke's replacing his baton under his tunic. Then he bade farewell to the musicians and returned to his castle." (Cited without reference in Hermann Knispel, *Das grossherzogliche Hoftheater zu Darmstadt* [Darmstadt: A. Koch, 1910], p. 10.)

66. See Friedrich Noak, "Darmstadt," in *Die Musik in Geschichte und Gegenwart*, vol. 3, col. 17.

67. Ernst H. Pasqué, *Musikalische Statistik des grossherzoglichen Hoftheaters zu Darmstadt* (Darmstadt: J. C. Herbert'sche Hof-Buchdruckerei, 1868), pp. 5, 7, and 11.

drums found their way to Darmstadt through the offices of Vogler himself.

The Imperial Opera in Vienna and its offshoot, the Philharmonic, both had their beginnings in the royal court orchestra, which during the eighteenth century included no less than thirty-two strings, ten woodwinds, four trombones, thirteen trumpets(!), and timpani.⁶⁸ The ensemble flourished under Otto Nicolai, who served not only as *Hofkapellmeister* but also as chief conductor of the opera and director of the Philharmonic until 1842. Nicolai enlarged the orchestra to an ultimate size of seventy musicians, most of whom came from the ranks of the Royal Opera.⁶⁹ Many of Franz Lachner's symphonic works were first performed in Vienna. His Symphony no. 3 in D Minor won a prize offered by the Gesellschaft der Musikfreunde and was subsequently premiered there. One of the many virtuosi in the opera orchestra (and in several other ensembles in Vienna as well) was the timpanist Anton Hudler (1784–1856), who played during Beethoven's residence in that city.⁷⁰ Nicolai's expert coaching paid off; according to the French critic Jacob Frédéric Lullin de Chateaueux, all the compositions were performed "with the greatest precision." His review concluded with the laudatory statement, "At last we can maintain, without any fear of contradiction, that we have never heard such a performance."⁷¹ During a trip to Vienna in 1845, Berlioz wrote that "both [orchestra and chorus] are first-class: the

68. See Johann Küchelbecker, *Allerneueste Nachrichten vom römisch-kayserslichen Hofe* (Hannover: J. J. Förster, 1732).

69. *Otto Nicolais Tagebücher*, ed. Wilhelm Altmann (Regensburg: G. Bosse, 1937), p. 223.

70. Hudler and the timpanists of the other Viennese orchestras are listed in Anton Ziegler, *Adressen-Buch von Tonkünstlern, Dilettanten, Hof-Kammer-Theater- und Kirchen-Musikern in Wien* (Vienna: A. Strauss, 1823), pp. 66, 70, 81, 89, 93, 101, and 150; and Albert J. Weltner, Alois Przystaupinsky, and Ferdinand Graf, *Das Kaiserliche-Königliche Hof-Operntheater in Wien* (Vienna: A. W. Künast, 1894), p. 62. See also Wilhelm Jerger, *Die Wiener Philharmoniker* (Vienna: Wiener Verlag, 1942), pp. 26–35; and Christl Schönfeldt, *The Vienna Philharmonic Orchestra* (Vienna: Bergland Verlag, 1957), pp. 9–13. On the early years, particularly under Nicolai, see Heinrich Kralik, *Das grosse Orchester: Die Wiener Philharmoniker und ihre Dirigenten* (Vienna: W. Frick, 1942), pp. 15–20.

71. *Revue et gazette musicale de Paris* 10 (1843): 160. Also: "The musical execution left nothing to be desired. One could say that it was at the level of genius and glory of these *maestri*."

orchestra especially, selected, drilled, and led by Nicolai, may be equalled but cannot be surpassed. Besides its steadiness, fire, and great mechanical skill, this orchestra has an exquisite sonorousness, owing doubtlessly to the accurate tuning of the instruments with each other and the perfect purity of intonation of the individual instruments." Berlioz termed the orchestra's operatic accompaniment "outstanding."⁷²

In England the Royal Opera at Covent Garden performed Meyerbeer's *Robert* in 1832, Bellini's *Norma* in 1847, *Les Huguenots* a year later, and Auber's *Masaniello* in 1849. Three of these works required four timpani.⁷³ The drummer was the ubiquitous Thomas Chipp (1793–1870), who also played at the King's Theatre, the Philharmonic Society, and the Royal Academy of Music, among other organizations.⁷⁴ The Covent Garden orchestra was smaller than many of its European counterparts. A contemporary music critic observed that "the orchestra is usually not strong [there were only thirty-nine players!] but is manned by very skilled musicians."⁷⁵

The first concert of the Philharmonic Society took place under the direction of the impresario Johann Peter Salomon in 1813. Seven years later Ludwig Spohr came to London as guest conductor, surprising the orchestra by leading it with a baton. In 1825 its director, Sir George Smart, led a performance of Weber's *Rulers of the Spirits*

72. *Memoirs of Hector Berlioz*, p. 372. A contemporary description of the Industrial Exhibition held that same year makes no mention of kettledrums in the section on musical instruments (*Wiener allgemeine Musikzeitung* 5 [1848]: 353).

73. See Richard Northcott, *Covent Garden and the Royal Opera* (London: The Press Printers Ltd., 1924), p. 67; and Harold D. Rosenthal, *Two Centuries of Opera at Covent Garden* (London: Putnam, 1958), p. 679ff. The orchestra in 1848 performed Rossini's *William Tell* with seventy-nine musicians, including sixty-one strings, six woodwinds, eight brass, and percussion (Henry S. Wyndham, *The Annals of Covent Garden Theatre from 1732 to 1897*, vol. 2 [London: Chatto and Windus, 1906], p. 191).

74. Chipp's biography is given in James D. Brown, *Biographical Dictionary of Musicians* (London: A. Gardner, 1886), p. 159; and Frederick J. Crowest, *The Dictionary of British Musicians* (London: Jarrold & Sons, 1895), p. 25. A short entry can be found in *The Dictionary of National Biography*, ed. Leslie Stephen and Sidney Lee (London: Oxford University Press, 1921), vol. 4, p. 259. See also Nancy Benvenega, "Thomas Paul Chipp: Berlioz's Timpanist," *Berlioz Society Bulletin* 73 (1971): 7–11.

75. Anon., "Über den Zustand der Musik in London," *Allgemeine musikalische Zeitung* 21 (1819): col. 750.

Overture (three timpani). Wagner conducted the Philharmonic in 1855, remarking that it was "a magnificent orchestra as far as the principal members go. Superb tone—the leaders had the finest instruments I have ever listened to."⁷⁶

In Italy, only the orchestra of La Scala in Milan had more than two drums. This no doubt provided the example for Bellini and Donizetti, both of whom wrote many operas which premiered there.⁷⁷ The most famous timpanist of the orchestra was Pietro Pieranzovini (1814–1885). Recognized as a true virtuoso by his colleagues, he was the favorite of Giuseppe Verdi and even wrote a concerto for kettledrums and string orchestra.⁷⁸ However, with the exception of Venice and Naples, the other orchestras in Italy were very poor by comparison. One listener widely criticized the playing in each and every section of these other ensembles, adding that "no one knows how to play [the] kettledrums."⁷⁹

Another factor influencing the introduction of three or more drums into the orchestra was the growing frequency of high notes called for by contemporary composers: for example, Bellini's *Norma* (g), Berlioz's *Symphonie fantastique* (f), Glinka's *Ruslan and Ludmilla* (g), Mendelssohn's *St. Paul* (f sharp), Schubert's *Unfinished Symphony* (f sharp), Schumann's *Das Paradies und die Peri* (f sharp), and Rossini's *Stabat Mater* (g). In addition, many works required two small drums:

76. Myles B. Foster, *History of the Philharmonic Society of London, 1813–1912* (London: John Lane, 1912), pp. 42, 80, and 244. On the orchestra in general, see Reginald Nettel, *The Orchestra in England* (London: J. Cape, 1948), esp. pp. 147–89. Richter's famous concerts included a performance of Liszt's *Faust Symphony*, for which four drums were required (Francis Hueffer, *Half a Century of Music in England* [London: Chapman & Hally Ltd., 1889], p. 87).

77. *Allgemeine musikalische Zeitung* 27 (1825): col. 132. If Hérold's reaction is any indication, the playing of the opera orchestras in Venice (another important center) was much too loud. Following a performance in 1815 he wrote that he couldn't hear the rest of the musicians or the singers because of the trumpets, trombones, and timpani. (Benoit Jouvin, *Hérold: Sa vie et ses oeuvres* [Paris: Huegel et Cie, 1868], p. 32f.)

78. See Carlo Schmidl, *Dizionario universale dei musicisti* (Milan: Sonzogno, 1928), vol. 2, p. 278. It must have been with Pieranzovini's talents in mind that Verdi wrote the demanding timpani part in the opening storm music of *Otello*. See below.

79. Quoted in an unsigned review of the *Almanach aus Rom für Künstler und der bildenen Kunst*, ed. Friedrich K. L. Sickler and Johann C. Reinhart, in the *Allgemeine musikalische Zeitung* 12 (1809): col. 916.

for example, Mendelssohn's *Capriccio brilliant* and Meyerbeer's *Robert le Diable* called for both *d* and *e*. No large kettle could be tensioned up to the *d*; and with the standard "high" drum of that period (usually 23 or 24½ inches in diameter) and very thick skin then in use, it was often impossible to tune the head all the way up to an *f sharp* or *g*.⁸⁰ When two such high notes were called for, a small third drum became mandatory. The Leipzig Gewandhaus had larger drums than the theater orchestra, which probably accounts for the necessity of having a third drum of smaller dimension for the music of Mendelssohn and Schumann, for example; both *St. Paul* and *Das Paradies und die Peri* received their premieres by the Gewandhaus orchestra. Again, perhaps the fact that the timpani at the Paris Opera were larger than those found in the other orchestras in that city explains in part the early introduction of a third drum there.⁸¹

Finally, a word must be said concerning the influence of grand opera on the writing for timpani. It was this genre that formed the

80. A real danger, of course, was that the head would tear, since the brackets for the tuning screws were fastened to the hoop by screws that penetrated the skin. Pfundt (*Die Pauken*), speaking from experience, recommended transposing these high notes down an octave. English drums were generally larger than those on the continent, making high notes often difficult to reach. For example, at a rehearsal of Meyerbeer's *Crociato in Egitto* in the old Haymarket Opera House, the timpanist, Goodwin, simply couldn't obtain the E flat required, transposing it downwards. The conductor stopped the orchestra and screamed, "Goodween, I want E flat and B flat!", whereupon Goodwin answered, "Then, sir, you cannot have it." (Cited without reference by Victor Pontigny, "On Kettledrums," *Proceedings of the Royal Musical Association* 2 [1875-76]: 50.) This procedure, by the way, was recommended by Berlioz when a particular note was hard to reach (*Grand traité*, p. 253). It was also followed in Germany and Italy (see Pfundt, *Die Pauken*, p. 9; and Carlo A. Boracchi, *Manuale pel timpanista* [Milan: Luigi di Giacomo Picola, 1842], p. 19f.). The London drums on which Goodwin played may well have been manufactured by Ashbridge, Distin, or Potter. Dr. Burney wrote that the timpani "of Mr. Ashbridge are more cylindrical, being much longer [i.e., deeper] as well as more capacious than the common kettledrum" (Charles Burney, *An Account of the Musical Performance in Westminster Abbey* [London: T. Payne & Son, 1785], vol. 2, p. 28f.). The tradition of using larger kettles was thus perhaps inspired by Handel's early use of the so-called artillery drums for special outdoor performances as well as the later use of huge instruments from the Tower of London for the Handel commemorative concerts.

81. Pfundt, *Die Pauken*, p. 24; and Kastner, *Méthode complète*, p. 18. Of course, it is arguable that the sudden demand for a note otherwise necessitating a quick change of pitch could have accounted for the acquisition of a third drum as a matter of convenience, given the often severe limitations of hand tuning.

arena for more progressive, adventuresome composition, rather than nonprogrammatic forms such as the symphony, always more conservative. Led by composers such as Auber, Hálevy, and, of course, Meyerbeer, nineteenth-century operas became more dramatic than their predecessors, developing subjects of heroic dimensions in large-scale treatments. Long musical numbers were connected by recitatives, and maximum use was made of vocal, orchestral, and scenic effects, including frequent modulations from key to key. Some composers—either in ignorance of machine drums or taking pity on the plight of timpanists with but the conventional pair of hand-screw timpani—left the notes in their scores tuned to the “old” notes, in spite of the fact that the rest of the orchestra had modulated to a new key, if time did not permit a rapid change of pitch. It goes without saying that this practice led to some excruciating dissonances! As we have seen, other operatic composers set the pace, as it were, by requiring a far wider variety and greater number of instruments than their counterparts in the symphonic sphere. Thus, whereas chamber music in the more intimate salons required only about twenty instrumentalists (Haydn’s orchestra in Esterházy being a typical case in point), performances in the biggest opera houses of Europe involved seventy or more players. In addition, these same composers wrote more demanding parts for all instruments, the timpani included.⁸²

What was a timpanist to do? First of all, unlike the performance of a symphony, when, if a change of key necessitated retuning between movements, the conductor could merely wait until the drummer was ready, the performance of an opera—its frequent key changes notwithstanding—obviously could not be interrupted for the mere convenience of the timpanist. So when time did not permit rapid retuning, especially before machine drums became commonplace, a third or even a fourth drum became at times an absolute necessity. Secondly, more and more timpanists objected to the dissonances mentioned

82. See Carse, *The Orchestra from Beethoven to Berlioz*, p. 18. As early as the 1830s, writers began to notice the difference: “In the opera nowadays there is often produced a great uproar with the timpani! *O tempora, o mores!*” (Wilhelm Schneider, *Beschreibung der musikalischen Instrumente* [Neisse/Leipzig: T. Hennings, 1834], p. 102).

above, "correcting" them by adding a third drum tuned in advance to the proper note.

* * *

Along with increasing the number of notes available by the use of additional drums and extending their range by making both larger and smaller kettles, the most important innovation was the introduction of devices for rapid tuning.⁸³ During the early nineteenth century numerous inventors, working hand-in-hand with mechanics and metalworkers, developed various means for rapidly changing the pitch of a drum, in so doing both hastening and simplifying the tuning so that not more than a single tension screw, foot device, or the kettle itself had to be turned by hand or foot. Unfortunately, it is very difficult to trace the specific roots of such inventions; and for instruments such as the timpani, built at that time usually to order in what might be called a "cottage industry," this is especially true.

83. By far the best and most comprehensive accounts of these technical developments are Nancy Benvenga, *Timpani and the Timpanist's Art: Musical and Technical Developments in the 19th and 20th Centuries* (Gothenburg: Gothenburg University, 1979), pp. 1-36; and Herbert Tobischek, *Die Pauke: Ihre spiel- und bautechnische Entwicklung in der Neuzeit* (Tutzing: Hans Schneider, 1977), pp. 145-260. Benvenga singles out fourteen continental and six English drums for detailed discussion. Diagrams and a chart or graph showing suggested lines of development of machine tuning are included. Tobischek examines the mechanisms of no less than fifty-one timpani in detail, providing two-dimensional drawings reconstructing what these instruments must have looked like. Another important source touching upon the highlights of the more important inventions, particularly in England, is James Blades, *Percussion Instruments and Their History*, 2d ed. (London: Faber & Faber, 1975). Most of the technical developments discussed in this article took place in the German and Austrian environments, culminating in the ubiquitous Dresden pedal timpani. Since few if any English or French machine drums came into widespread and continuous use during this early period (their unique mechanical systems were not adopted elsewhere), they are not included here, and only those timpani whose mechanisms were of primary technological importance or which were actually manufactured and in general use are mentioned. English patents are cited by Benvenga, *Timpani and the Timpanist's Art*, footnotes on p. 30. Supplementing Tobischek, many French patents are included in the publication *Subject-Matter Index of Patents for Inventions Granted in France from 1791 to 1826 Inclusive* (Washington: U. S. Government Printing Office, 1883), p. 238. See also L. A. de Pontécoulant [Adolphe le Douclet], *Organographie* (Paris: Castel, 1861), vol. 2, p. 529ff., for a list of tuning mechanisms, few of which ever saw the light of day. Copies of French patents are obtainable through the Service de Documentation of the Institut Nationale de l'Industrie in Paris.

Mechanical technology during this period was subject to considerable improvements stemming from a variety of sources in a relatively short space of time. There was a profusion of inventions that can be traced to the spread of education, the opportunities and demands of industrialism, and the ready availability of ferrous metals in various forms. Mechanical technology differed from chemical or modern electronic technology, for example, in that it did not usually require great resources of capital or trained manpower in order to develop a successful idea and put it into practice. Consequently, much of nineteenth-century ingenuity went into the creation of mechanical devices for every purpose whatsoever, and the knowledge thus fostered was widely disseminated via journals, semipopular newspapers or magazines, mechanics institutes, and other educational means such as night schools. By this time, both scientific instrument makers and mechanics had produced a rich and varied repertory of devices large and small, and metalworking skills were more than adequate to produce the required machinery. In addition, by 1811 the *École Polytechnique* had published charts and plates of a wide variety of machine elements, and the question of proper shapes for gear teeth gave rise to a large number of drawings that mechanics could have seen or have been told about by the inventors themselves. From 1802 to 1819 the *Cyclopaedia* of Abraham Rees was published in England, and profusely illustrated French technical dictionaries appeared from 1820 on. Thus, locksmiths and armorers, for example, would have had no trouble whatsoever in producing the tuning device for a kettledrum, being already familiar with castings, rods, screws, nuts, and various gear mechanisms.⁸⁴

84. Abraham Rees, *The Cyclopaedia; or Universal Dictionary of Arts, Sciences and Literature* (London: Longman, Hurst, Rees, Orme & Brown, 1819–20). For this information I am indebted to Dr. Eugene S. Ferguson, Curator of Technology, The Hagley Museum, Wilmington, Del., and Prof. Bert S. Hall, Institute for the History and Philosophy of Science and Technology, University of Toronto, both of whom read a draft of this article and offered helpful comments. One further note: as in the case of so many ideas, Leonardo da Vinci had anticipated these developments some 300 years previously. Among his notebook drawings dealing with the automation of musical instruments is the sketch of a machine drum with a spider mechanism consisting of what appears to be either cords or rods connecting the hoop to a disk below the kettle, along with a crank attached to a screw underneath it for changing the tension (MS

However, many of their solutions proved to be too complex and unstable. The inertia of their mechanisms prevented easy tuning, and they failed to provide for even tension around the drum's rim. It was often difficult to maintain the pitch without fluctuation. Since most models did not have counterhoops or separate tuning screws or T handles, adjustments to compensate for the skin's uneven thickness or minute changes in humidity could not be made. Furthermore, these drums still required at least one hand to operate, making simultaneous playing and tuning all but impossible. Being entirely hand-made, they were very expensive compared to ordinary timpani, and only a few models were sufficiently reliable mechanically to be successfully mass-produced.⁸⁵

A convenient way of classifying machine drums is to divide them into those with the tuning mechanisms on the exterior, almost like an armature, and those with the device inside the kettle itself. The former category included drums tuned by a single cranking device and those

Arundel 263, fol. 175). As usual, Leonardo was ahead of his time; and this device was scarcely applicable to Renaissance music (drum parts were not written down, nor were rapid pitch changes applicable to the music of that era, if indeed precise tuning was accomplished at all around 1500); and his manuscripts were unknown to these early nineteenth-century inventors. See Emmanuel Winternitz, "Melodic, Chordal, and Other Drums Invented by Leonardo da Vinci," in *Raccolta Vinciana*, fasc. 20 (1964), esp. pp. 57–59.

85. The patent office archives of every country are crammed full of inventions that were never realized, or, having been made, were quickly and mercifully assigned to oblivion, owing to their technical drawbacks, their unpopularity in the marketplace, or their lack of a competitive edge. Kastner (*Méthode complète*, p. 22), writing only some thirty-odd years after the first machine drum appeared, took pains to point out the unreliability of many of these instruments: "Unfortunately, several obstacles remain to be overcome, and we are convinced ourselves that the same difficulties have stopped the progress of inventors from solving these problems." Specifically, these drawbacks were the complexity of the devices themselves, their lack of mechanical strength, and their inability to maintain pitch. However, in some cases these early models "served their purpose as long as their respective inventors were there to look after them and see that nothing went wrong." (Carse, *The Orchestra from Beethoven to Berlioz*, p. 422.) See also Georg Fechner, *Die Pauken und Trommeln in ihren neueren und vorzüglicheren Konstruktionen* (Weimar: B. F. Voigt, 1862), p. 17: "But as with so many other inventions [where] the expectations exceeded the results, so this is also the case with several types of machine drums. For only too often these [drums] are purchased for rather high prices, and then, when it comes right down to it, [they] haven't proven to be much better than ordinary timpani."

whose pitch was altered by rotation of the instrument around a central screw. The interior mechanisms were divided into those utilizing a cable and turnbuckle or rack-and-pinion type of tuning device and those consisting of one or more concentric rings that were pressed up against the inner side of the skin from within.⁸⁶

The first significant step was taken in Bavaria, when in 1812 Gerhard Cramer, *Königlicher Hofpauker* in the Munich court orchestra (formerly quartered in Mannheim), invented the first device for effecting rapid tuning. It was no accident that this occurred in a region known since the late Middle Ages for mechanical instrumentation and computerlike devices of amazing ingenuity. For example, the manufacture of sophisticated armor, often involving screw attachments, was centered in Augsburg and Milan, while Nuremberg became the great place for clocks and fine metalwork.⁸⁷ Munich itself was perhaps the most cosmopolitan of German cities at that time.⁸⁸ Mechanical technology of all sorts was exploited at the royal court, where complex instruments such as astronomical models, clocks, and automata were constructed. The opera house, with its marvelously ingenious stage sets requiring extensive machinery, relied heavily upon these developments.⁸⁹ Among others, it was the locksmiths who

86. Slightly different, but equally valid, approaches towards classification are found in Benvenge, *Timpani and the Timpanist's Art*, p. 34 (central disk, internal hoop, and cable types), and Tobischek, *Die Pauke*, p. 270 (screw, rotating, and pedal types). It seems curious that nobody thought of attaching a cable or chain around the rim of the kettle connecting the tensioning screws by means of tiny gears, and thus turning them all by means of a single or pair of opposing T handles. Apparently, the successful realization of this simple device had to await the invention of the more reliable bicycle-type chain-and-sprocket mechanism. (The concept itself is unrelated to the early cable and turnbuckle tuning discussed below.) Similarly, William F. Ludwig, Sr., in the early years of this century, was the first to combine an interior armature with an exterior mechanism by pushing rods through holes in the kettles and attaching them to pivoting tuning screws, but that's another story.

87. For calling my attention to these developments, my thanks to Lynn White, Jr., Professor Emeritus of the History of Technology at the University of California, Los Angeles, who read an early draft of this article.

88. A late eighteenth-century visitor from the north described Munich as "the German Rome" (Franz Muncker, "Ein Berliner über München vor 100 Jahre," *Jahrbuch der Münchner Geschichte* 1 [1887]: 173-75).

89. See for example J. [Giuseppe] A. Borgnis, *Traité complet de mécanique appliquée aux arts*, vol. 8: *Des machines imitatives et des machines théâtrales* (Paris: Bachelier, 1820), esp. pp. 274-98.

turned the learned discipline of mechanics into practice. Buttressed by great skill in practical design, these men were able to turn often highly theoretical or complex ideas into workable models.⁹⁰ By about this time, thanks to its hardness, cast iron was becoming widely used for all sorts of devices, and machine shops were outfitted with tools for turning out practically any kind of mechanical element, including gear wheels.

Thus, it is not at all surprising that the enterprising Gerhard Cramer turned to the court metalworking shop and a locksmith named Traub for help in the actual design of his mechanism, and to the royal armorer and metalworker Pittky for the fabrication of the drums themselves. Following the instructions of Cramer and Traub, and making some improvements of his own, Pittky fashioned two prototype pairs of instruments, differing slightly from each other in design. According to a contemporary reference, tuning was accomplished "in a flash," and Cramer's timpani "stood to ordinary drums as the pedal harp to the diatonic model."⁹¹

What in fact did Cramer's mechanism look like? Unfortunately, neither the drums themselves nor verified, contemporary drawings seem to have survived; and there is no record of any royal charter or letters-patent having been granted the inventor. All that remains are brief descriptions in near-contemporary documents and a diagram

90. Studies of locksmithing and door hardware are too numerous to mention. The source used here is F. W. Schlegel, *Kulturgeschichte der Türmschlösser* (Duisberg: Verlag Fachtechnik, 1963), p. 49.

91. Anon., "Neue Erfindung," *Allgemeine musikalische Zeitung* 14 (1812), Intelligenz-Blatt no. 61 (October), unpaginated. Apparently, Cramer had been occupied with the problem of how to tune the drums mechanically for some time, no doubt motivated in part by the increasing demands of the "new" music being performed by the Munich court orchestra. An interesting coincidence is the fact that one of the earliest representations of large timpani not on horseback was painted by the Bavarian court painter Hans Mielich for both Cipriano de Rore's book of twenty-six motets (1559) and Orlando di Lasso's *Penitential Psalms* (1567-70), presented to Duke Albrecht V. Both manuscripts (Mus MS B, page 113 and Mus MS AII, page 181) are in the Bayerische Staatsbibliothek in Munich. Even the somewhat earlier pictures by Albrecht Dürer (the *Book-of-Hours of Maximilian* [1515]) and Hans Burgkmair (the contemporaneous *Die Geschicklichkeit in der Musik* in Marx Tretzaurwein's *Der Weissskunig*) could be said to have been influenced by the Bavarian/Austrian court environments. The proximity to Hungary and the east brought these large instruments into their orbits beginning in the late fifteenth century.

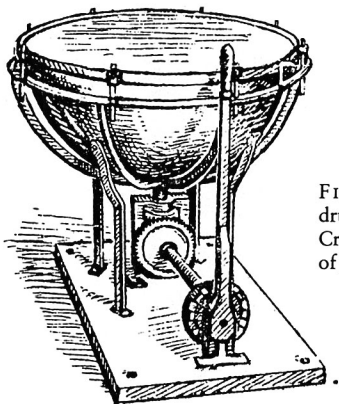

FIGURE 1. Drawing of a machine drum, probably that of Gerhard Cramer (Munich, 1812). Courtesy of James Blades.

associated with a general reference to the first machine-tuned timpani. The drum itself was firmly attached to a wooden base by means of metal struts bolted to the kettle. The metal hoop, or rim, was equipped with tuning screws, which in turn were affixed to a parallel ring immediately below. This ring was supported by an armature curving around the bowl and terminating at a central screw. Tuning was accomplished by a vertical lever operating a horizontal axle which turned a crown gear, thus raising or lowering the central screw and with it the attached armature and hoop to which the drum head was lapped (fig. 1).

Is this indeed Cramer's very own drum? Certainly, it corresponds to the most precise early written description of the instrument.⁹²

92. Karl F. Schafhäutl, "Bericht über die musikalische Instrumente auf der deutschen Industrieausstellung in München," in *Bericht über der Beurteilungskommission bei der allgemeinen deutschen Industrieausstellung* (Munich: G. Franz, 1855), p. 201. For whatever it's worth, both Dr. Benvenge and I came to the same conclusion associating this drawing with Cramer's instrument quite independently, completely unaware of each other's work. Concerning any possible efforts to patent the device, inquiries to the Deutsches Patentamt and Haupt-Staatsarchiv in Munich proved fruitless. The files of both the State Ministry for the Interior and the Polytechnische Verein in Bavaria were not begun until 1825; hence, no inventions prior to that date can be traced. The supposed diagram of Cramer's drum cited in the introduction to William F. Ludwig,

Furthermore, many of its physical characteristics conform to those of other contemporary instruments. For example, the kettle is rather shallow; the supporting struts are similar to those found in other timpani of the early 1800s; and the tuning screws are also typical. More important, Cramer's lever and gear mechanism, employing the long, horizontal stroke, or action, of a lever to move the armature attached to the rim, is extremely primitive when compared with its increasingly sophisticated successors. Indeed, the device corresponds neatly to the level of mechanical technology found in the south German orbit at that time. Whatever the case, it was an ingenious tuning device that took full advantage of current "know-how"; and, in its use of an external armature connecting the tuning screws to a central element for raising or lowering it and thus controlling the tension of the drum head, it anticipated the later and most successful type of machine drums. While Cramer's device certainly represented a rather primitive approach to the problem—with its massive gear mechanism one might almost say "mechanical overkill"—it was at least a good start, a quantum jump forward from primitive hand screws.

For whatever reason, Cramer sold his models (and, presumably, the rights to his invention as well) to Georg Vogler, who had come to Munich on business in August 1812. Vogler, in turn, shipped the drums to Darmstadt for the court orchestra of Archduke Ludwig I.⁹³

The Amsterdam musician-inventor Johann Stumpff (1770–1841) introduced a rotating type of machine drum around 1815. Born in a

Sr., *Timpani Instructor* (Chicago: WFL Drum Co., 1957) as coming from a booklet published by the Leedy Drum Manufacturing Company in Indianapolis in 1920 was in fact a drawing of quite another machine kettledrum invented by Max Puschmann in 1880.

93. G. E. Anders, "Perfectionnement des timbales," *Revue et gazette musicale de Paris* 5 (1838): 278; also Schafhäütl, *Abt Georg Vogler*, p. 67. Ottmar Schreiber (*Orchester und Orchesterpraxis in Deutschland zwischen 1780 und 1850* [Berlin: Junker & Dünhaupt, 1938], p. 196) says that Cramer "sold his patent [*sic*] to Vogler." In spite of queries to the Hessisches Landesmuseum and Landesbibliothek in Darmstadt, no information on Cramer or his drums has turned up. According to Dr. Jürgen Wolff of the Hessisches Staatsarchiv, no references to the instruments in question are to be found in Vogler's correspondence with either Archduke Ludwig or Prince Emil. Without doubt, the timpani themselves were lost, either in the 1871 fire that destroyed the opera house or during the bombing of Darmstadt in 1944.



FIGURE 2. Rotary-tuned machine drums of the Stumpff type (German, ca. 1821). Courtesy of the Africana Museum, Johannesburg (Inv. no. KG122).

suburb of Leipzig, he immigrated to Holland while a member of the Prussian music corps "Oranje-Nassau" and by 1798 had established himself there as an orchestral performer.⁹⁴ In his novel system, a large screw attached perpendicularly to a wooden base (much like a low stool) penetrated the bottom of the kettle through a large nut. Inside, it was attached to an internal armature of four iron struts that terminated immediately below the drum head in a metal ring. The head was mounted in the conventional manner and tuned initially by means of tension screws and a hand key. When the drum was rotated from left to right, for example, the whole instrument lowered itself on the central screw (much like a desk chair), the interior ring pressed tighter against the skin, and the pitch was raised (fig. 2). This procedure was simple enough, and in the confident words of a fellow timpanist, "a musician with little practice has only to give a small turn . . . in order to change the note in less than a second." Perhaps more realistically, another writer said that tuning could be accomplished in one or more measures (*allegro*), depending upon how great the interval was.⁹⁵

The main disadvantages of Stumpff's system were that both hands of the player had to be used to turn the drum, thus interrupting

94. While the year 1821 is cited in all the standard sources for this invention (the year he applied for the equivalent of a patent), according to an unsigned article in the *Allgemeine musikalische Zeitung* 17 (1815): col. 407, Stumpff introduced his rotary-tuned drums in that same year. The text goes on to point out carefully that in order to insure Stumpff's claim to his new invention, it had been announced in the *AmZ*, and that had Winkel done the same he would have been credited with having invented the metronome instead of Mälzel!

95. Kastner, *Méthode complète*, p. 19; and Fechner, *Die Pauken und Trommeln*, p. 15f. See also the *Neues Universal-Lexikon der Tonkunst*, ed. Eduard Bernsdorf, vol. 3 (Dresden/Offenbach: R. Schaefer, 1861), p. 144; and Henri Viotta, *Lexikon der Toonkunst*, 3 (Amsterdam: P. N. van Kampen & Zoon, 1885), p. 117, who quotes a report by Stumpff himself that appeared in the proceedings of the Koninlijk Nederlandsch Instituut for 26 November 1820. Just where Stumpff got the idea for his rotating timpani is not known, although the swivel chair was itself a nineteenth-century invention. Perhaps he started by observing the action of a piano stool, then a new device, and reasoned that an analogous principle could move a tuning mechanism. However, the first screw jack had appeared during the Middle Ages and was obviously nothing new; the notebooks of Villard de Honnecourt (ca. 1235), for example, and later manuscript illuminations show lecterns mounted on spiral posts, presumably to regulate their height rather than serving as pure ornament. Again, my thanks to Lynn White, Jr., for this information.

playing and requiring that both sticks be temporarily set aside, and since rotation (retuning) altered the beating spot, the (to many) ideal point—the back portion of the skin rather than the belly—was not necessarily always in front of the player. However, because they were cheap to make, lightweight, and easily transported, Stumpff's drums were ideal for the town musician who had to perform in different locations. Apparently they were quite popular before being superseded by other models and were often purchased in the Netherlands and in the Rhine region.⁹⁶ Mendelssohn's favorite timpanist, Ernst Pfundt, reported having seen a pair of Stumpff timpani in Karlsruhe in 1844.⁹⁷

Vienna reflected the same kind of environment as Munich: a sophisticated court that depended upon a high degree of technical know-how on the part of fabricators of all sorts who worked within its orbit. A tuning mechanism was first mentioned in 1831 when, in applying unsuccessfully for the position of timpanist in the imperial orchestra, Georg Hudler stated that he had invented a machine drum.⁹⁸ A prototype model may well have been constructed by his father, the well-known timpanist Anton Hudler (1789–1856). Referred to as an “excellent German timpani virtuoso,” he had studied with Anton Edler, married Edler's daughter, and later succeeded his father-in-law in the court orchestra in 1814. Georg Hudler later became first timpanist in the Vienna Philharmonic in 1842.⁹⁹

Very little is known about the precise construction of Anton Hudler's instrument. Apparently (quoting the inventor himself), tuning all tension screws equally was accomplished “by a single motion” up or

96. See *Ernst Pfundts Paukenschule neu bearbeitet . . . von Hermann Schmidt*, 3d ed. (Leipzig: Breitkopf und Härtel, 1894), p. 12. In England, H. J. Distin patented a rotating drum with rod tensioning on the exterior of the kettle in 1856. Curved bars connected the upper hoop to a fitting at the bottom of the shell. Pitch changes were effected by turning the drum, thus altering the tension. George Potter invented a similar mechanism in 1884. See *Blades, Percussion Instruments*, pp. 254, 278, and 289.

97. Pfundt, *Die Pauken*, p. 36.

98. The document itself, dated 4 April 1831 and addressed to the king, is quoted in Tobischek, *Die Pauke*, p. 160.

99. See Richard Hochrainer, “Beethoven's Use of the Timpani,” *Percussionist* 14 (1977): 66f. Earlier reference to a pair of Hudler drums in the possession of the Vienna Musikverein are incorrect. According to recent information from the institution itself, it has never owned them.

down.¹⁰⁰ Other sources confirm that he “invented a workable arrangement, or at least modified it, to tighten all screws of the drum with one pull.”¹⁰¹ George Kastner reported that the drums produced “a tone of great purity,” but in spite of such favorable comments, Hudler’s instruments were apparently never manufactured for general use and, like so many other machine drums of this period, were limited to fairly local use and then soon forgotten.¹⁰²

Another inventor mentioned in contemporary sources was Charles Blumenröder (b. ca. 1789), a composer and the city music director in Nuremberg beginning in 1816.¹⁰³ His machine drum was tuned “by means of an easy hand motion”; and in his own words it was reliable and quick and could be made “without causing a disturbance,” meaning, presumably, without noise from the mechanism itself.¹⁰⁴ Christian Reinhardt reports that Blumenröder’s instruments were “acclaimed and admired” by musicians and that orchestras in Amsterdam, Hamburg, Coburg, and the cathedral of Eichstädt had purchased them. He also noted that orders could be delivered in from five to six weeks at a price of 88 florins per drum.¹⁰⁵

100. Georg Hudler, in Tobischek, *Die Pauke*, p. 160. See also Ignaz Jetteles, *Aesthetisches Lexikon* (Vienna: I. G. Ritter von Mosle’s Witwe und Braumüller, 1839), p. 176.

101. Gustav Schilling, *Encyclopädie der gesammten musikalischen Wissenschaften*, 3 (Stuttgart: F. H. Köhler, 1835), p. 644. Hermann Mendel, *Musikalisches Konversationslexikon*, ed. A. Reismann (Berlin: L. Heimann, 1870–73), vol. 5, p. 319, quotes Schilling almost verbatim: “a working arrangement to pull all the screws simultaneously.”

102. See Heinrich Knauer, “Die Pauken,” in *Musikinstrumentenkunde in Wort und Bild*, ed. Emil L. Teuchert and Erhard W. Haupt, vol. 3 (Leipzig: Breitkopf und Härtel, 1911), p. 165f.

103. Blumenröder’s scanty biography is given in Fétis, *Biographie universelle*, vol. 1, p. 449; and Robert Eitner, *Biographisch-bibliographisches Quellen-Lexikon*, 2 (Leipzig: Breitkopf und Härtel, 1900), p. 73.

104. Fechner (*Die Pauken und Trommeln*, p. 15) says that the timpani could be tuned “easily and surely and in a moment to each semitone by an easy motion of the hand without turning the kettle, without disturbance, and without the help of a second person.” The fact that they were “the size and weight of ordinary timpani” suggests their portability.

105. Reinhardt, *Der Paukenschlag*, p. 11. Pfundt, reporting in the *Neue Zeitschrift für Musik* 19 (1843): 43f., says that Blumenröder’s drums received a gold medal in an exhibition at the Frankfurt Trade Association in 1837 and that orchestras in Paris and Cologne already possessed them.

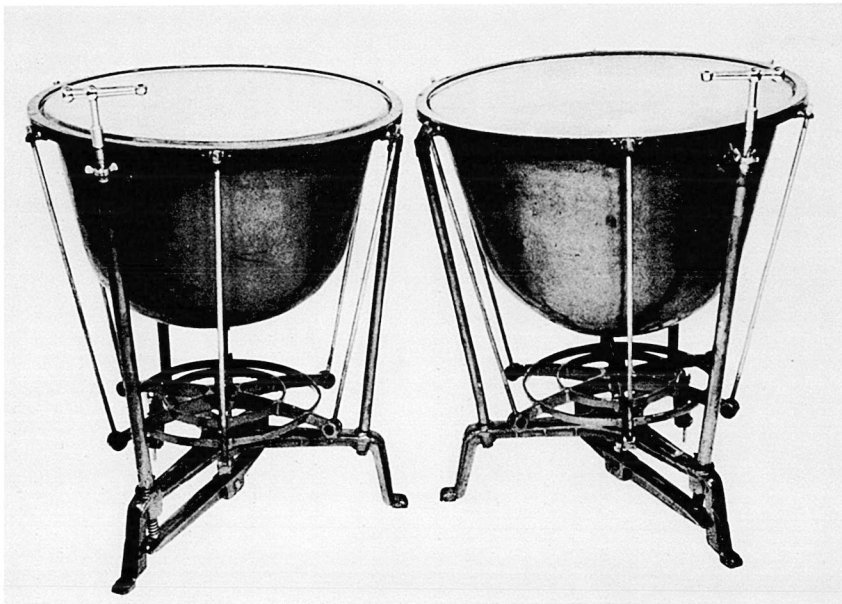

FIGURE 3. Modern German machine drums with Einbigler-type tuning device. Courtesy of Lothar Harloff and Eckehard Keune.

Johann Kaspar Einbigler (1797–1869) from Frankfurt invented an important prototype mechanism for rapid tuning in 1836 and in fact built his own drums as well.¹⁰⁶ He suspended the copper bowl from its upper portion by means of metal struts terminating in short iron legs below. The hoop over which the skin was lapped was attached to eight vertical supporting rods functioning in addition as individual tuning screws, all of which terminated in a thin, weblike base plate directly below the kettle. Action by a threaded, vertical tuning crank pressing against a pivoted lever, or rocker arm, below the plate raised or lowered the entire base assembly (rods and hoop), thus lessening or increasing the skin's tension (fig. 3).¹⁰⁷

106. Interestingly, Einbigler was listed as both a sieve- and drum-maker in the *Katalog der Abteilung Frankfurts*, ed. Arthur Richel (Frankfurt/Main: Gebrüder Knauer, 1929), vol. 2, p. 129. The earliest reference to him seems to be in Anders, "Perfectionnement des timbales," p. 278; unfortunately, his article provides no details on the instrument's mechanism. It is very possible that Einbigler was motivated to design a drum with more efficient tuning by the timpanist of the Frankfurt orchestra, Carl Gollmick, who was critical of the limitations of kettledrums long after machine tuning had been introduced (*Autobiographie von Carl Gollmick* [Frankfurt/Main: Druck und Verlag von C. Adelmann, 1866], part 1, p. 118f.). In mentioning Meyerbeer, Donizetti, Halévy, Auber, Marschner, and Mendelssohn, he observes that "even the newest construction with a screw hardly sufficed to satisfy all the demands which our exacting composers made regarding such super-fast retuning."

107. See the *Allgemeine musikalische Zeitung* 38 (1836): col. 495. Gollmick himself used Einbigler's machine drums, and he described and recommended them as well. See his article, "Die neuen Pauken des Herrn Einbigler in Frankfurt-am-Main," *ibid.* 47 (1845): esp. col. 160. Sounding like a commercial, the text states that the timpani "grant to the timpanist a thousand advantages never dreamed of before; because this [new] construction stands by comparison to the former type like a locomotive to a horse and carriage during the Renaissance." Describing the crank mechanism with which the drum was tuned, Gollmick mentions the precise construction and uniformity of pressure on the skin. "By this means, of course, the greatest speed is assured, because now one can fine-tune or retune two timpani in less time than it takes to reach for the key on the music stand. Second, every kind of disturbing clatter is omitted; and, third, one can tune even while playing, in which case one either takes both sticks in one hand or, if absolutely necessary, moves the crank by a slight pressure of the elbow. These overwhelming advantages [over hand-tuning kettledrums] are immediately apparent and need no further explanation." (Gollmick even anticipated Bartók and other modern composers in experimenting with a glissando, executing a roll while another percussionist turned the crank!) In his *Autobiographie* (part 1, p. 104), Gollmick refers to this inventor as follows: "But [just] like Mr. Schnyder of Wartensee, the mechanic Mr. Einbigler (who subsequently introduced his single-screw timpani with such remarkable success), and later Mr. Winzheimer—one of our primary musical amateurs

The tone of these machine drums was rounder and fuller, owing to the fact that the kettle was suspended and thus able to vibrate freely, without any extensive internal machinery that would impede the sound waves. Einbigler's timpani were apparently so impressive that several composers, including Mendelssohn himself, signed a joint statement describing them to the musical community at large.¹⁰⁸ The Leipzig timpanist Pfundt reported having seen them in Munich, Frankfurt, Paris, and Cologne.¹⁰⁹ He also mentioned that they were being made by the coppersmith Glanert in Leipzig and that several sets had already been dispatched on order.¹¹⁰ Another witness offered the testimonial that the "rapid" tuning was "amazing."¹¹¹ Again, one cannot point to a specific mechanical device as the source for Einbigler's invention, but the use of a threaded screw acting upon a rocker arm (translating horizontal cranking motion to vertical lift, as it were) represented a far more efficient solution to the problem than Cramer's lever and gears.

On 9 December 1837 a British patent was issued "unto Cornelius Ward, of Great Tichfield Street, Mary-le-Bone, Musical instrument maker, for his invention of 'Improvements on the musical instruments designated drums'."¹¹² Two types of unique tuning mechanisms were included. In the first, the head was tensioned by means of an endless cord or wire cable passing over pulleys from the exterior to

—were faithful advisors [to me]." The description in *A Dictionary of Music and Musicians*, ed. George Grove, vol. 1 (London: Macmillan & Co., 1879), p. 465, is incorrect. The use of a bar to pull the spider mechanism downwards had its analog in the regulating arm in grain mills, long used to lift or lower the upper millstone in order to adjust the clearance between upper and lower stones.

108. Carl Guhr, Ferdinand Hiller, Felix Mendelssohn-Bartholdy, and Ferdinand Ries, "Sehr zweckmässige Verbesserung der Pauken," *Allgemeine musikalische Zeitung* 38 (1836): col. 495.

109. Ernst G. Pfundt, "Maschinen-Pauken für grosse Orchester," *Neue Zeitschrift für Musik* 19 (1843): 143. The identity of the Einbigler machine drums that Pfundt saw is discussed in full in Benvenega, *Timpani and the Timpanist's Art*, p. 9.

110. Pfundt, *Die Pauken*, p. 36.

111. Schilling, *Encyclopädie*, vol. 5, p. 397. See also the description in Bernsdorf, ed., *Neues Universal-Lexikon der Tonkunst*, vol. 3, p. 144.

112. Ward was identified as a maker of flutes, bassoons, and drums. See Lyndsay Langwill, *An Index of Musical Wind-Instrument Makers*, 4th ed. (Edinburgh: privately printed by the author, 1974), p. 184.

the inside of the kettle, where it passed through pairs of pulleys attached to two threaded T bars. These bars approached or receded from each other by means of a long horizontal screw or double turnbuckle with right- and lefthanded threads at each end, respectively. This turnbuckle formed a rod running through the interior of the kettle and terminating at one end in a wooden handle outside the drum. When the timpanist turned this handle to the right or left, the cable was pulled tighter or loosened as the two T bars moved closer together or farther apart on the turnbuckle. Thus, the pitch was raised or lowered accordingly (fig. 4).¹¹³

There were two principal disadvantages to this first design of Ward's. The lack of tensioning screws made it impossible to compensate for the uneven pressure on the skin, due to the fact that tension on the cable itself was least at the point farthest away from the turnbuckle. In addition, tuning changes had to be made by turning the handle with the player's wrist, a weak spot in human anatomy, and when the skin was under high tension the torque made twisting the rod very difficult. However, in spite of these drawbacks, Ward's early machine drum continued to be manufactured (principally in an improved version by George Potter in Aldershot) until the late nineteenth century.

Ward's second, far superior device employed a mechanism typical of the locksmith's art. A number of levers were connected to the hoop over which the drum head was stretched. These levers were divided into two pairs, one of which was bent to the right and the other to the left. The lower ends of each pair were engaged in a movable horizontal bar, each of which overlapped the other at their movable ends. They were racked, or toothed, with one set pointing upwards and the other downwards. By turning a notched pinion inserted between these two racks, or bars, a corresponding motion was given to each set of levers connected to the hoop, thus tightening or relaxing the

113. Specifications as well as detailed drawings are to be found in British patent no. 7505. See Bennet Woodcroft, *Titles of Patents of Invention, Chronologically Arranged* (London: H. M. Stationery Office, 1854), vol. 2, p. 1029. Copies of Ward's patent (as well as other foreign ones if the dates or serial numbers are known) are available through the Foreign Section of the U.S. Patent Office in Crystal City, Va. Ward's cable-type machine drum served as the model for a French design produced by the instrument maker Gautrot in 1854.

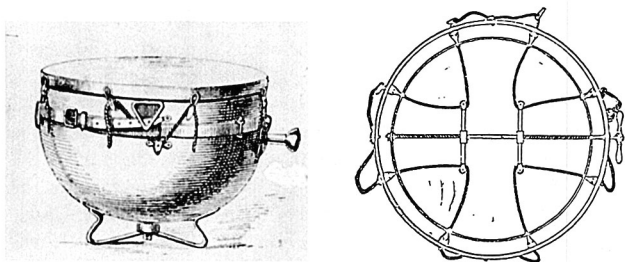

FIGURE 4. Cable-tuned machine drum invented by Cornelius Ward (1837). Side view from *Ernst Pfundts Paukenschule*; top view from the *Transactions of the Society of Arts, Manufactures and Commerce*.

skin according to which direction the pinion's handle was turned (fig. 5).¹¹⁴

Ward's new machine drums were tried out in 1836 and 1837 at Covent Garden as well as at the Philharmonic concerts in London, and they found immediate acceptance in several other English and continental orchestras as well.¹¹⁵ However, the inventor was unsuccessful in his attempts to get the Philharmonic Society to use his timpani on a permanent basis. In correspondence with the orchestra's conductor, Sir George Smart, Ward complained about the opposition

114. See Cornelius Ward, "Improved Method of Tuning a Kettledrum," *Transactions of the Society of Arts, Manufactures and Commerce* 51 (1835-37): 37. On the device's dependence upon the locksmith's art, see for example Paul Grützmacher, *Der Schlosser*, rev. Karl Otto (Leipzig, B. F. Voigt, 1923), vol. 2, p. 37. The completely different technological bases of English and central European machine drums would make an interesting study. Certainly, Ward's first turnbuckle device suggests more of an affinity to naval hardware than to scientific instrument building.

115. See Fechner, *Die Pauken und Trommeln*, p. 10: "[The drum] invented by the Englishman Cornelius Ward has been used for a long time by the Italian Opera [i.e., Covent Garden] in London as well as in other English theaters"; also Adolf Deutsch, *Pauken-Schule zum Selbst-unterricht geeignet* (Leipzig: Carl Merseburger, 1894), p. 11: "The English machine kettledrum, invented by Cornelius Ward, has been successfully used for some time in the greatest theaters of England"; and George Hogarth, "Musical Instruments: Instruments of Percussion," *The Musical World* 5 (1837): 83: "We understand that a patent has been taken out for an invention of this kind, and that drums so constructed have been procured by the Philharmonic Society."

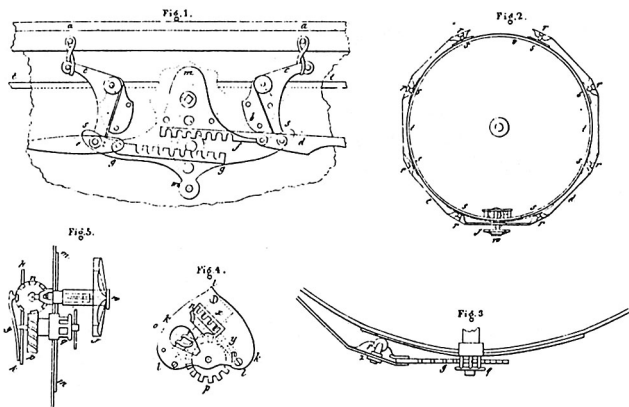

FIGURE 5. Diagram of Ward's rack-and-pinion tuning mechanism. From patent specification no. 7505.

he had encountered from conservative timpanists.¹¹⁶ This inherent resistance to technological innovation seems, alas, to be deeply ingrained in human nature; and one wonders how many other machine drums were rejected for the same reason.

Returning to the Bavarian environment, the next important tuning mechanism was invented by August Knocke (1793–1863), a gunsmith in Munich. Around 1840 he conceived of a rather elaborate system of gears to allow the performer to alter the drum's pitch. The vertical rods attached to the counterhoop terminated in a large wheel placed directly underneath the kettle. At the center of this supporting disk was a threaded hole through which ran a screw. This in turn was connected below to a gear meshing with a series of cog wheels operated by a small control wheel near the base of the drum. When rotated by the player's feet, the horizontal motion was translated into a vertical thrust which either raised or lowered the wheel with its rods connected to the hoop, thus altering the tension of the head. A hand crank also interlocked with the series of gears for fine tuning and

116. Foster, *History of the Philharmonic Society*, p. 137.

activated an adjustable gauge indicating the pitch on a graduated plate. The massive iron base consisted of two parallel iron rings, the larger of which sat on the floor and supported the upper ring by means of four vertical bars. From this higher ring, eight struts conforming to the shape of the kettle ran up to its lip, thus supporting the drum from its flange underneath and permitting it to vibrate freely (fig. 6).¹¹⁷

Knocke's device was novel as far as musical instrument building was concerned, although in some respects it resembled those of Cramer and Boracchi (see below, fn. 141). It offered for the first time a tuning mechanism that left the hands of the player completely free for performing while tuning the drums. The technology used was very contemporary; numerous machines of that period employed ring gears, cog wheels, and cams of all sorts. For example, a decade later adding machines appeared utilizing these elements, followed soon thereafter by the cash register. As a manufacturer of firearms, Knocke doubtlessly had access to machine shops using the latest designs and techniques.

Despite their complex machinery, Knocke's machine drums were used in a number of German orchestras, principally at the court theater in Munich (*Königlich Bayerisches Hoforchester*), where they remained in use well into modern times.¹¹⁸ It is possible that Wagner's entire *Ring of the Niebelung* was composed with these timpani in mind.¹¹⁹ In 1851 the drums received honorable mention at the

117. Tobischek, *Die Pauke*, p. 175ff.

118. Schafhützl, *Bericht*, p. 203. Manufactured by the J. Kaltenecker firm, two pairs were acquired in 1841, remaining in continuous use for a hundred years. During World War II the timpanist of the Munich Opera lapped new heads to one pair of these drums, which had been removed to another building for that purpose so that the heads would dry. On 2 October 1943 the National Theater was bombed, and the remaining pair in the orchestra pit were destroyed. The surviving drums continued to be used until 1963. One of these is on display at the Deutsches Museum, while its mate remains stored in the Prinzregententheater. See Nancy Benvenga, "August Knocke's Timpani," *Percussionist* 16 (1978): 34.

119. Benvenga, *Timpani and the Timpanist's Art*, p. 84. Be this as it may, Wagner thought that timpani from London (Ward's?) were the best ones being made, noting especially the superiority of British materials and metalworking. The fact that he mentions English mechanics in this context suggests some sort of machine drum (*Die königliche Kapelle betreffend*, in Kapp, ed., *Der junge Wagner*, p. 389).

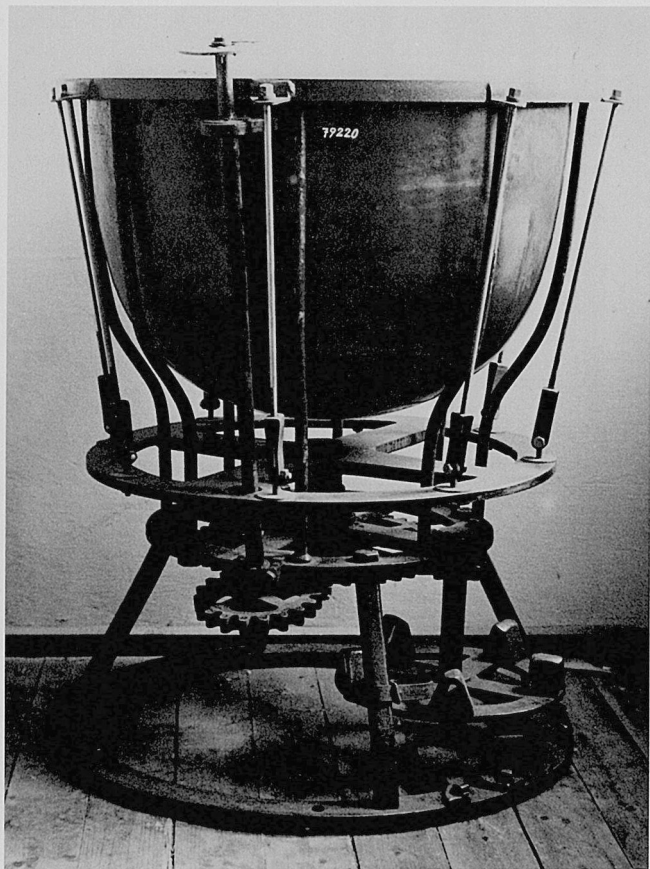

FIGURE 6. Foot-activated machine drum invented by August Knocke (ca. 1840). Courtesy of the Deutsches Museum, Munich (Inv. no. 79220).

Great Exhibition in London, and three years later they won a medal of honor at the German Industrial Exhibition in Munich. Ernst Pfundt saw a set of Knocke's timpani in both Munich and the opera house in Berlin around 1843. But apart from their beautiful tone, his reaction to the "very complicated and in part useless [*sic*] mechanism" was negative. He found the tuning to be slow and cumbersome, owing to the use of the foot to turn the small operative wheel, and the drums themselves were terribly heavy and difficult to move.¹²⁰

Doubtlessly, Pfundt's firsthand knowledge of machine drums he had seen and tried out in Paris, London, Vienna, Berlin, Munich, and Prague influenced his own modest attempts to help advance the state of the art.¹²¹ Since by that time he himself used Einbigler timpani in the Leipzig orchestra, it was only natural for him to seek out a mechanic and fabricator, Glanert, who was turning out the Einbigler model. Pfundt made suggestions for improving the tuning mechanism which were incorporated into the manufacturing process; but what exactly these changes were can only be surmised. However, perhaps some idea of the direction these technological improvements were

120. See Pfundt, *Die Pauken*, p. 35: "A second type, transported with even more difficulty, I first saw in the [National] Theater in Munich. Their tone is . . . beautiful . . . because it is not the kettle but the support[s] that carry the weight. However, since the tuning is done with the foot, one cannot retune as quickly and as securely as with the hand-operated, single-tension screw model. A wheel that in turn activates a smaller gear to which is affixed the main screw accomplishes the tuning. Later on, I saw the Munich type of drum [again] in the Berlin Opera House, where I myself rotated [i.e., tuned] them, but with difficulty." His first reference to Knocke's timpani appeared in the *Neue Zeitschrift für Musik* 14 (1843): 143. See also Heinrich Welcker von Gontershausen, *Die musikalischen Tonwerkzeuge, dargestellt in technischen Zeichnungen aller Saiten-, Blas-, Schlag-und-Frictions-Instrumente* (Frankfurt/Main: C. Winter, 1855), p. 413: "In the Munich Industrial Exposition such pedal [*sic*] timpani were shown by the locksmith Berger from Nuremberg, H. Tempele of Neutischein in Moravia, and A. Knocke, mechanic, from Munich. But experts do not deign to give praise to this machinery. Therefore, the drums do not yet find acceptance." This seems to be confirmed by the similar experience of Cornelius Ward (see above). How much of this was simply resistance to technological change and fear of the new, as opposed to legitimate reaction against unreliable mechanisms, is hard to say.

121. Several authors mistakenly attributed the later pedal mechanism to Pfundt, thus perpetuating considerable confusion on the subject. See for example Arthur Elson, *Orchestral Instruments and Their Use* (Boston: L. C. Page & Co., 1902), p. 259; and Otto Kristufek, *The Ludwig Tympani Instructor* (Elkart: Ludwig & Ludwig, 1930), p.

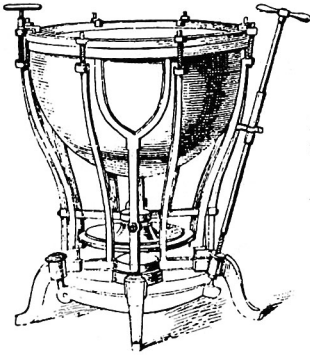

FIGURE 7. Pfundt/Hoffmann type of machine drum (Leipzig, ca. 1850). From *Ernst Pfundts Paukenschule*.

taking can be seen by examining the next step in the drum's evolution: the so-called Pfundt/Hoffmann timpani.

Friedrich Hentschel, the celebrated timpanist of the Royal Opera orchestra in Berlin, made further improvements on the Einbigler/Pfundt machine drum, a set of which he used between 1853 and the 1880s.¹²² These timpani were manufactured in Leipzig by an engineer named Carl Hoffmann—hence the name that, along with Pfundt's, served from then on to identify that particular type of instrument. The kettle was made larger and the entire iron assembly much heavier. To better support the instrument, the framework, in the form of forked braces, was attached at the very rim of the bowl rather than on its

122. In spite of his own claims, Hentschel's technical improvements were only minor. See Tobischek, *Die Pauke*, p. 190. Concerning his recognized skill, "wonderful things were told about the absolute accuracy of [Hentschel's] playing." One anecdote mentions a dress rehearsal of Meyerbeer's *Le Prophète*. "In one aria there is a drum roll to be executed *piano*. The nervous composer didn't consider the passage to be soft enough, and stopped the orchestra with the remark that the timpani were too loud. There was another start, and again Meyerbeer stopped and called, 'Timpani, more *piano*!' At that point Hentschel became annoyed, having played this part many times [before] and always to the conductor's satisfaction; and he remarked to his neighboring colleague, 'Well, today the old man complains about everything. This time I'm not going to play at all!' The aria began anew. The eyes of the timpanist were glued to the conductor, the passage was played, and his sticks rested motionless upon the drum. 'Bravo, bravo my dear Hentschel!' Meyerbeer called out, 'just a bit more *piano*!'" (Anon., "Die Pauken," *Zeitschrift für Instrumentenbau* 23 [1902–03], 835.)



FIGURE 8. Pfundt/Hoffmann drums (modified) owned by the Vienna Philharmonic. Courtesy of Richard Hochrainer, Vienna.

side. Reinforced cross pieces were added below, connecting opposite supports. The thin, perforated base plate was replaced by a massive disk. In place of a small pin projecting from the bottom of this plate (to which the pivoting lever was connected), a thick, vertical axle pierced the disk and connected the rocker arm (fig. 7).¹²³

Pfundt/Hoffmann drums were acquired by orchestras in many of

¹²³. See Pfundt, *Die Pauken*, p. 33f.; Deutsch, *Pauken-Schule*, p. 11; and *Pfundts Paukenschule*, p. 11. The drums depicted here in fig. 8 are the thirty-third set manufactured by Hoffmann, now the property of the Vienna Philharmonic. The counterhoops were removed (probably by the timpanist Hans Schnell) and replaced by the typically Viennese brackets atop each supporting rod which bear on the lapped hoop itself. Apparently as late as 1873 Pfundt/Hoffmann drums were still being manufactured. See Luigi F. Valdrighi, *Nomecheliurgografia antica e moderna ossia elencodi fabbricatori di strumenti armonici* (Modena: Società Tipografica, 1884), p. 44. The timpani, with slight variations, were still being described and illustrated in Deutsch (1894) and in Fritz Volbach, *Das moderne Orchester in seiner Entwicklung*, 1 ("Die Instrumente des Orchesters, ihr Wesen und ihre Entwicklung"), 2d ed. (Leipzig, 1921), p. 110.

the major cities in Europe. One timpanist records having seen them in France.¹²⁴ A set received honorable mention at the Vienna World's Fair in 1873; and the eightieth pair fabricated by Hoffmann was similarly honored at the Dresden Trade Show two years later.¹²⁵ Since the Leipzig Gewandhaus orchestra owned four of these drums, Pfundt obviously played on them before his retirement. Their apparent popularity served to underscore their several advantages. Since the kettle itself was suspended at its rim, bearing hardly any tension, it could not only vibrate freely but the copper could be hammered much thinner than in other models, thus (according to Pfundt himself) producing an "extraordinary tone." The entire spider mechanism consisting of hoop, rods, and base plate was extremely strong and stress-resistant, while the screw mechanism itself had far less inertia to overcome than in older models, thus making fine tuning far easier (fig. 8).

Just how much Pfundt and Hentschel each contributed to the overall design of the tuning device remains a matter of some speculation.¹²⁶ Both men, with perhaps pardonable pride, made vague claims of their own. Since, in his own words, he "improved upon" Einbigler's timpani, it is probably fair to say that Pfundt thought up certain revisions (such as a stronger supporting mechanism, for example) that were realized and no doubt refined by Glanert. Hentschel, too, said that he "designed" an improved version of this drum; but since it was Hoffmann who manufactured them on order over a period of several decades, it is logical to assume that he, too, had an

124. Otto Seele, *Pauken-Schule zum Selbstunterricht* (Leipzig: Breitkopf und Härtel, 1895), p. 5.

125. According to the author of a report on musical instruments at the Vienna Exposition, "a pair of timpani with mechanical device of most excellent quality was furnished by C. Hoffmann in Leipzig. The armature is fashioned in such a way that the drums are free-standing. The machinery is so complete and at the same time so easy to use that the instrument can accommodate every pitch change in the most facile manner imaginable. The tone is marvellous." (Eduard Schelle, "Musikalische Instrumente," in *Officieller Ausstellungs-Bericht herausgegeben durch die General-Direktion der Weltausstellung* [1873], ed. Karl T. Richter [Vienna: K. K. Hof- und Staatsdruckerei, 1874], vol. 29, p. 80.) See also Tobischek, *Die Pauke*, p. 189ff.

126. Of the early sources, only the *Zeitschrift für Instrumentenbau* 23 (1903): 835, states emphatically that Pfundt did not in fact "invent" a machine drum. Many writers merely refer to the "Pfundt/Hoffmann" kind of timpani and leave it at that.

important hand in whatever alterations were made.¹²⁷ Be this as it may, the Pfundt/Hoffmann design and the refinements made by their successors represented important innovations in a tradition of design that solved the dual problems of inertia and lack of speed found in early screw- and gear-type mechanisms. Their contribution was a single, threaded crank acting upon a pivoted lever that controlled the armature to which the tuning rods were attached. More significant was the fact that this simple device multiplied the force transmitted to the base plate by the tuning crank, making for a far more efficient and powerful mechanism. And, like Einbigler's earlier model, these newer machine drums allowed the kettle to vibrate freely, without any internal or external mechanical encumbrances, thus improving the quality of sound.

A machine drum with an interior tuning device was invented and manufactured by Louis Jena in Reudnitz, then a suburb of Leipzig.¹²⁸ The kettle itself was suspended in a semicircular, curved frame which in turn was mounted on a large central shaft with a screw thread attached to the metal base. Thus, for the first time, a drum could be raised or lowered much like a modern desk chair and tilted as well to suit the performer. Conventional tuning bolts were provided. The inner mechanism consisted of two levers working against each other on which wedges were fastened, all activated by a horizontal screw with an exterior handle. By means, then, of lever, wedge, and screw, a ring just inside the top of the kettle was pushed up against the skin to alter the pitch (fig. 9).¹²⁹ The timpani were portable, weighing only

127. See Ernst Pfundt, *Die Pauken*, 2d enlarged ed. rev. Friedrich Hentschel (Leipzig: Breitkopf und Härtel, 1880), footnote on p. 24. The link connecting Einbigler, Pfundt, Hentschel, and Hoffmann is obvious; but the relative contributions of the latter three remain unclear. Several authors state that Hoffmann, rather than Pfundt or Hentschel, was the true inventor. See for example the *Handlexikon der Musik*, ed. Friedrich Bremer (Leipzig: P. Reclam, 1882); Mendel, *Musikalisches Konversationslexikon*; Schuberth, *Musikalisches Conversations-Lexikon*; and Peter J. Tonger, *Konversationslexikon der Tonkunst* (Cologne: Wilhelm Hassel, 1881-85). These authors may or may not be correct, but, since they wrote several decades after the fact, the question remains open.

128. According to Schuberth (*Musikalisches Conversations-Lexikon*), Jena received a patent for his tuning mechanism on 22 September 1877.

129. See *Ernst Pfundts Paukenschule* (3d ed.), p. 11. Hentschel (*ibid.*, 2d ed., p. 28f.) also mentions the facility with which, for example, a high *f* could be obtained, unlike

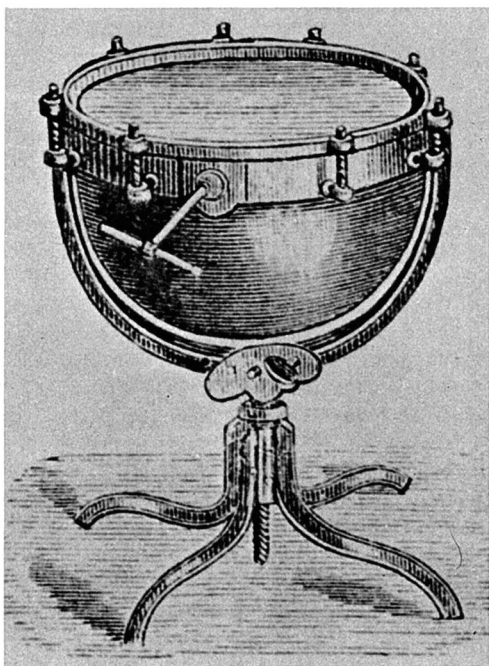

FIGURE 9. Kettledrum with Louis Jena tuning mechanism (Reudnitz, 1877). From *Ernst Pfundts Paukenschule*.



FIGURE 10. Early model of Dresden-type pedal kettledrum with Pittrich mechanism, manufactured by Focke (ca. 1895). From the *Zeitschrift für Instrumentenbau*.

about 130 pounds per pair. Jena's important contribution was the notion of a tuning mechanism that could be easily added to an existing hand-tuning drum. The Leipzig manufacturer Glanert, who also made Stumpff rotary timpani on order, refitted old kettles with this new device.¹³⁰

We now come to the final stage in the evolution of machine tuning during the nineteenth century: the so-called Dresden model invented by Carl Pittrich, *Kapelldiener* of the Royal Saxonian Orchestra. A native of Dresden, he had been a student at the local conservatory, but, outside of his occupation as a musician, nothing else is known about his activities.¹³¹ As in the case of his predecessor Jena, what

on some other timpani. See also Tobischek, *Die Pauke*, pp. 202–4. A very similar machine drum was designed and built by Kohler in England between 1860 and 1880. Again, a single internal loop pressed up against the skin, activated by a cam controlled by a worm gear. A central tuning handle penetrating the side of the kettle was provided with a built-in tuning gauge in the form of an indicator that moved in and out of the drum as the handle was turned. See Blades, *Percussion Instruments and Their History*, plate 133.

130. Pfundt, *Die Pauken*, p. 36.

131. Pittrich's biography is given in von Brescius, *Die Königlich sächsische musikalische Kapelle*, p. 64. He is not to be confused with Georg Pittrich, a composer, pianist, and choral director of the Royal Saxonian Orchestra, to whom he was probably related.

Pittrich actually developed was a tuning device (*Stimmvorrichtung*) meant to be attached to an existing drum. Patented in 1881, it was manufactured first as a separate mechanism by the firm Ernst Queisser Nachfolger and later as a complete drum assembly by Paul Focke in Dresden (fig. 10).¹³²

The Dresden model differed from its predecessors in employing a foot pedal, ratchet, and mechanical couplings as a tuning device, changing the entire mechanism into an eccentric for converting the semicircular motion of the pedal into the reciprocating motion of the base plate up and down. Again, it is difficult to pinpoint the exact source for this invention, although the concept was used widely in steam engines, punch presses, and the like, as well as machines controlled by treadle linkages, such as the common mangle used in commercial laundries. The pedal itself was attached to a lever, at the upper end of which was a heavy club or ball acting as a counterweight. At its other end the lever was affixed to a shaft that conveyed motion to the actual tuning device by means of various mechanical couplings. Specifically, an eccentric activated a horizontal lever pivoting from the base plate. By means of a bolt flexibly attached at the center of this lever, the heavy plate was moved up or down. The tuning rods connected thereto pushed or pulled the metal counterhoop accordingly, lowering or raising the drum head and thus altering its pitch. To accomplish this action, the player's heel was pressed outward against a spring, disengaging it from a sawtoothed clutch and releasing the pedal. After moving it up or down to find the desired pitch, the heel was slid back to its normal posture, re-engaging the ratchet and locking the pedal into its new position. In spite of the

132. The inventor of several other improvements to musical instruments (such as the five-string contrabass), Queisser was also the member of a musical family that contributed two brothers to the brass section of the Dresden Royal Opera orchestra, Friedrich and Gottlieb. See Riemann, *Musik-Lexikon*, p. 733. In 1900 the Focke firm was taken over by the mechanic Jähne, who, along with Heinrich Knauer, timpanist of the *Dresdner Staatskapelle*, further developed Pittrich's model around 1910. The timpani were made lighter and the kettles themselves larger. Currently, these drums—virtually unchanged—are being manufactured by the Dresdner Apparatenbau. Surprisingly, neither F. A. Dreschel, "Zur Geschichte des Instrumentenbaues in Dresden," *Zeitschrift für Instrumentenbau* 49 (1928-29): 995-1000, nor the *Address-Buch deutscher Export Firmen*, ed. Walter Annecke and Henry Bueck (Berlin/Leipzig: O. Spanner, 1883), mentions Queisser or any other drum manufacturer.

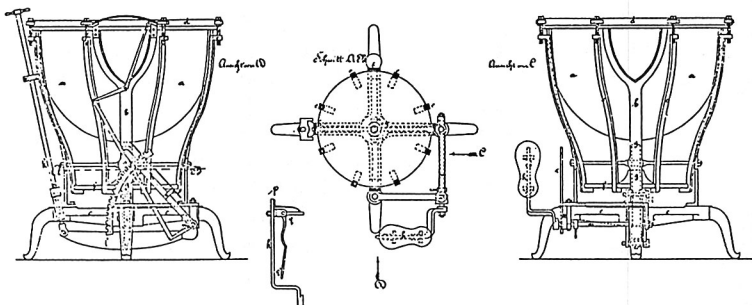

FIGURE II. Diagram of Pittrich's pedal tuning device. From patent specification no. 15199.

relative ease of operating this mechanism, the foot pressure required must have been considerable, since the player's chair had to be fastened to the floor so that it would not slip backwards as he worked the pedals. A tuning gauge controlled by a linkage to the pedal indicated the correct pitch by means of a pointer and adjustable markers. For fine tuning made necessary by momentary changes in temperature and humidity or the pressures of heavy beating on the vellum, the single master screw was used (fig. 11).¹³³

From a musical point of view, Pittrich's mechanism was truly a giant step forward in the history of timpani that ended forever the severe limitations placed upon composer and performer alike. From the standpoint of design it represented the ultimate refinement in substituting for the screw mechanism a foot pedal with ratchet and eccentric capable of converting and multiplying the pedal's force sufficiently to overcome the resistance of the base plate and move the rim with its supporting struts up and down. While the simple tuning screws around the rim could exert more direct force than any other device, they did so at a severe cost in speed; and thus the Dresden model achieved ultimate success by substituting a far more rapid and

133. Von Brescius, *Die Königlich sächsische musikalische Kapelle*, p. 13; Deutsch, *Pauken-Schule*, p. 13; Anon., "Die Pittrich'sen Pedal-Maschinen-Pauken," *Zeitschrift für Instrumentenbau* 23 (1903): 636f.

powerful tuning mechanism for its predecessors. Moreover, it was the first drum whose pitch could be changed reliably by the foot while the timpanist continued to play with both hands.¹³⁴ It solved the problem of how to correct an out-of-tune note without interruption. The innovative tuning gauge, when properly adjusted, provided for the first time a precise indication of the drum's pitch, absolutely essential when there was no time to carefully tap the skin with finger or stick in order to verify the intonation or to make any necessary adjustments accordingly.

Finally and most important, the wholesale adoption of the Dresden model was made easier by the fact that the pedal mechanism had been designed specifically to be installed on existing drums of the Pfundt/Hoffmann type (fig. 12).¹³⁵ Consequently, those many orchestras already in possession of these instruments could easily and economically convert them to pedal timpani. The way was led by Otto Lange, timpanist of the court orchestra in Dresden, who, with the encouragement of its conductor, Ernst von Schuch, had his drums equipped with the new pedal tuning mechanism (fig. 13). As far as is known, this is the only pair of original Pittrich timpani still extant.¹³⁶ In Lange's own modest words, "quite surprising results are possible."

134. This innovation is similar in concept to the improvement on the sewing machine. In 1850 Isaac Singer marketed the first such device operated by a hand crank. Subsequently, he added a treadle mechanism which freed both of the operator's hands to control the fabric being sewn. Indeed, the Dresden timpanist Otto Lange compared the pedal timpani to "a sewing machine without wheels" (see below, fn. 137).

135. Among the countless writers on the timpani since that time, only Heinrich Knauer seems to have noticed this critical fact (Teuchert and Haupt, eds., *Musik-instrumentenkunde*, vol. 3, p. 166).

136. According to Peter Sondermann, first timpanist of the *Staatskapelle*, this pair was presented to the court chapel in Dresden by the royal princess. The orchestra itself performed there during services every Sunday. Much later, the drums found their way to the large rehearsal stage of the State Opera, housed in the Marstall, a former riding academy, where they miraculously escaped damage during the bombing of Dresden in World War II. Much too heavy to be transported, and lacking the volume of sound characterizing the larger, more recent instruments, these drums with Pittrich's pedals are no longer in use. The late William F. Ludwig, Sr., saw a set of three such instruments (imprecisely described as Pfundt drums) in use since 1881 during a trip to Europe. Extremely heavy, "the pedal action was very stiff, weighted by a large iron ball [which would identify them as of later manufacture], and not at all capable of the rapid changes we know of in America today." (*A Brief History of the Tympani* [Elkhart: Ludwig & Ludwig, n.d.], p. 8.)

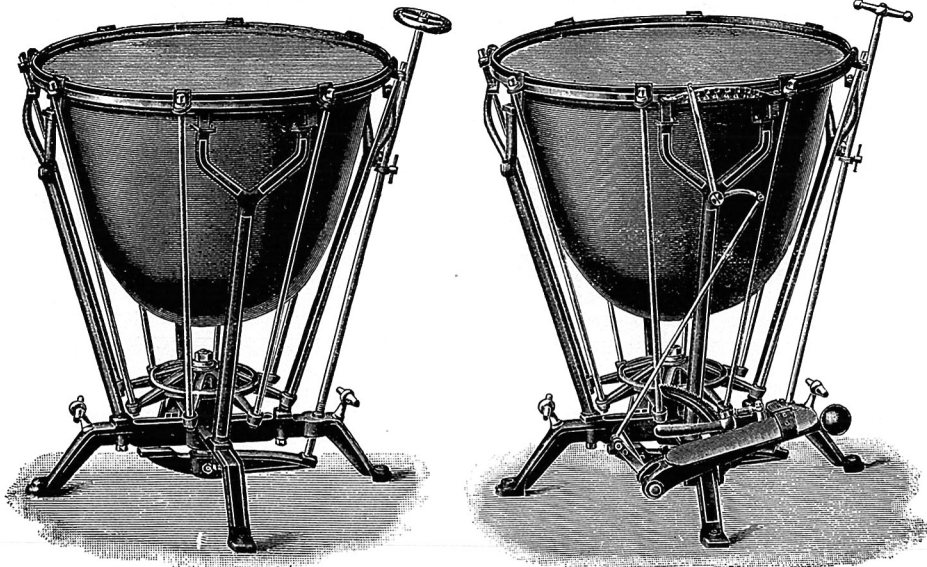

FIGURE 12. Pfundt/Hoffmann kettledrum (left) and a drum of the same type with a Pittrich pedal tuning device installed (right). From E. Teuchert and E. W. Haupt, *Musikinstrumentenkunde in Wort und Bild*.

TABLE 2

Lengths of Time for Changing Pitches of Timpani in Various Works

Year	Composer	Work	Tuning change	Approx. time
1821	Weber	<i>Der Freischütz</i> , Overture	A to G	70 sec.
1830	Berlioz	<i>Symphonie fantastique</i> , 5th mvt.	{ c sharp to c G sharp to G }	50 sec. 25 sec.
1841	Schumann	Symphony no. 4 in D Minor, 1st mvt.	{ d to d flat and A to A flat } { d flat to e and A flat to A }	23 sec. 30 sec.
1846	Mendelssohn	<i>Elijah</i> , no. 16	e flat to e	5 sec.
1866	Thomas	<i>Mignon</i> , Overture	B flat to A	4 sec.
1871	Verdi	<i>Aida</i> , act 4	A to B	6 sec.
1874	Wagner	<i>Die Götterdämmerung</i> , act 3	{ d to e flat and G to B flat }	7 sec.
1879	Smetana	<i>Ma Vlást</i> , 5th mvt.	d to e	6 sec.
1879	Bruckner	Symphony no. 5 in B flat, 4th mvt.	B to c	6 sec.
1887	Verdi	<i>Otello</i> , act 1	e to d to c	instantaneous
1895	Mahler	Symphony no. 3 in D Minor, 1st mvt.	{ e to f and A to B flat }	2 sec.
1895	Strauss	<i>Til Eulenspiegels lustige Streiche</i>	c to c sharp	instantaneous
1903	D'Indy	Symphony no. 2 in B flat, 4th mvt.	{ B to B flat to A to A flat }	instantaneous

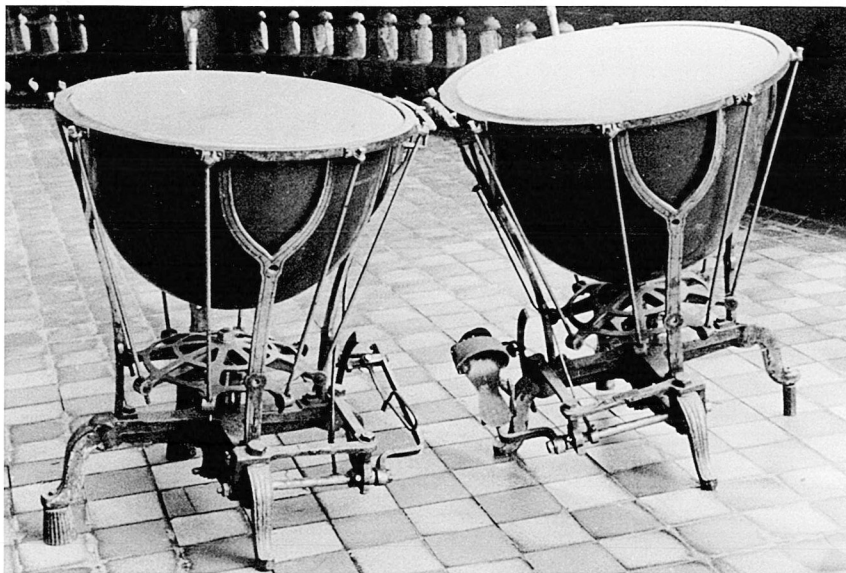

FIGURE 13. Original pair of machine drums outfitted with Pittrich's mechanism constructed by Ernst Queisser (1881). Courtesy of Peter Sondermann, Dresden.

With practice, Lange was able to play the famous passage from Meyerbeer's *Robert le Diable* (see above, ex. 4) on two timpani.¹³⁷ Similarly, the three Pfundt/Hoffmann drums in the Leipzig Gewandhaus orchestra were converted to pedal timpani.¹³⁸

The effect of the invention of machine tuning on composers during the nineteenth century becomes immediately apparent when one examines the time allotted for changing a drum's pitch in various works composed over a span of time (table 2). In the case of early composers such as Weber and Berlioz, these retunings could easily be made and verified with hand-tuning timpani; and indeed there is no evidence whatsoever that either of them wrote with machine drums in mind or even had them at their disposal. However, by the time of Schumann and Mendelssohn, for example, such instruments were already in use, as we have seen, in the major opera houses and symphony orchestras in Europe. In this connection, Schumann's Symphony no. 4 in D Minor is virtually unique for this era and genre in requiring that the pitches of both drums be changed three times

137. Otto Lange, in an untitled article in the *Musikalisches Wochenblatt* 21 (1881): 248. Knauer, in the citation above (fn. 135), mentions being able to play "God Save the Queen" (a melody Haydn used as "Heil dir im Siegerkranz") on a pair of Pittrich pedal timpani.

138. Why did the tuning screw mechanism have such a tenacious grip as a design element for so long? Possibly this was a case in which tradition developed around a slightly false analogy. Since from the very beginning changing the pitch of timpani was accomplished by hand screws, it was reasoned that all further approaches to the problem had to use the same mechanism as a point of departure. Another hypothesis has to do with the availability of materials. The various screw mechanisms would certainly have generated considerable stress, but probably within the range of metals then available. Therefore, it is significant that Pittrich's system appeared only after the availability of cheap, high-quality steel in continental Europe. Still in rather limited production as a special-purpose material, steel was soon to replace wrought iron in both old applications and new ones, thanks to the basic processes invented by Henry Bessemer (blowing air through molten cast iron) and William Siemens (an open-hearth furnace process), which represented one of the greatest technological revolutions in metallurgical history. Indeed, steel was an ideal metal for a pedal mechanism and, because of the torque generated by the device's action, may well have been a necessary material for it. Thus, the Dresden type of pedal timpani is a good example of changes in machine design made possible by this new material. Again, my thanks to Prof. Bert Hall for this information. See also Cyril S. Smith, "Mining and Metallurgical Production, 1800-1880," in *Technology and Western Civilization*, ed. Melvin Kranzberg and Carroll W. Pursell, Jr., vol. 1 (New York: Oxford University Press, 1967), pp. 303-38.



EXAMPLE 12. Giuseppe Verdi, *Otello* (1887), Introduction to act I.

during a movement, and in one instance within the space of less than a minute. While arguably not beyond the capabilities of hand-tuning timpani (and a skilled performer), such changes were much easier and more reliable with the help of some sort of tuning mechanism, especially when larger intervals were involved. By the 1860s composers were asking that all sorts of tuning be accomplished in a few seconds—a feat either extremely difficult or often impossible without the aid of some sort of hand crank or pedal. This suggests, furthermore, that by then most composers assumed that the major orchestras performing their works already possessed machine drums of one kind or another.¹³⁹

139. The best account of this whole development is in Benvenaga, *Timpani and the Timpanist's Art*, pp. 55–78. However, hand-tuning drums remained in use until after World War II, especially in smaller orchestras. The music encyclopedias, too, continued to focus on these instruments, often to the exclusion of pedal timpani altogether. See for example the *Musikalisches Lexikon*, ed. Arrey von Dommer (Leipzig: F. W. Grunow, 1865), pp. 672–75; and Riemann, *Musik-Lexikon*, p. 682f. Even Curt Sachs selected a hand-tuning drum for illustration in his *Handbuch der Musikinstrumentenkunde*, 2d ed. (Leipzig: Breitkopf und Härtel, 1930), p. 84. (While stationed in Paris in 1945, I attended a performance at the Opéra Comique in which four hand-tuning brass timpani were used.) A virtually identical quartet of various-sized drums is illustrated in Baggers, “Les timbales,” fig. 762 on p. 1693 (also very probably the source for Sachs’s figure). The English, too, were notoriously conservative, favoring hand-tuning timpani (as well as wooden flutes, French bassoons, and piston-valve horns) long after most opera and many symphony orchestras on the continent and in the United States were already using pedal timpani. Ebenezer Prout, *The Orchestra*, 1st ed., vol. 1 (London: Augener & Co., 1897), p. 245: “Some of the more recently made drums are provided with a patent mechanism by means of which the tuning of a single screw changes the pitch, almost instantaneously; but, as such drums are not in general use, the composer cannot depend upon getting them.” See also Kirby, *History of the Kettle-Drums*, chapt. 2 and plate opposite p. 22; Christoph Caskel, “Trommeln und Pauken (neuere Zeit),” *Die Musik in Geschichte und Gegenwart*, vol. 13, col. 757f.; and written comments from Jeremy Montagu, London. According to Benvenaga (*Timpani and the Timpanist's Art*, p. 23), machine drums were first introduced into England in 1905 when Sir Henry Wood imported a pair of Dresden pedal timpani for use by his Queen’s Hall Orchestra, where they remained the only such pair by a major orchestra for approximately twenty years. (These drums now reside in the Royal Academy of

While other methods of mechanical tuning continued to be used, it was the so-called Dresden model pedal timpani that held the stage, as it were, and, with minor changes and improvements, remained in widespread use to the present day.¹⁴⁰ Indeed, virtually all composers from the late nineteenth century onward owe Pittrich and his successors a debt of gratitude; for without this kind of facile, reliable mechanism, much of their music would remain virtually unplayable, and they would have been forced into the expediency of compromising their creative spirits to a considerable degree.

A typical case in point is the stormy introduction to Verdi's *Otello* (1887) which calls for four different notes in rapid succession (ex. 12). While this passage could have been executed with four hand-tuning drums (forgetting the later changes required), such a performance would have demanded unusual agility in quickly alternating between the highest and lowest drums at a rapid tempo as well

Music in London and are illustrated in Blades, *Percussion Instruments and Their History*, fig. 136.) Benvenga also makes the important point that, for the more ambulatory English orchestras, transportability was a key factor. The cumbersome German timpani proved to be much too heavy. When, much later, the English did start to build pedal timpani themselves, they based the designs upon the much lighter American models.

140. With many baroque timpani safely ensconced in museums and private collections, it may seem strange that so few nineteenth-century machine drums survive. One must remember that by this time kettledrums were no longer prized trophies of war, and their ceremonial functions had been progressively stifled. Unlike the situation with old violins, for example, whose modern counterparts haven't changed and which are made all the more valuable by time itself, the rapid pace of technological improvements to the timpani during this period made all previous models immediately obsolete. Moreover, timpani were unique in that they were seldom made by instrument builders *per se* but first by coppersmiths. With the introduction of machine tuning, however, these craftsmen were displaced by the locksmith, armorer, and mechanic, who thereafter assumed the primary role in fabricating these instruments. Even when timpani were made to order, it was a machine-shop operation rather than a manual craft. Consequently, there was no longstanding tradition of connoisseurship; and timpani were—and continue to be—viewed as mechanisms rather than works of art. Unfortunately, little care was ever taken to preserve the specimens of the past. Finally, the almost symbiotic relationship between a musician and his instrument—an extension of his body, head, and fingers—is not present between a timpanist and his kettles. It is the sticks, after all, which touch the skins; and the size of the instruments themselves precludes holding or embracing them as one would a precious stringed instrument or woodwind. The violin tucked protectively under the chin, or the oboe gently embraced by the fingers, is a physical relationship totally lacking with the timpani.

Scherzo

46

47

48

49

f

mf

p

p

p

EXAMPLE 13. Gustav Mahler, Symphony no. 2 in C Minor ("Resurrection") (1894), third movement.

as the use of three small instruments for the notes *c*, *d*, and *e*. It is far likelier that timpanists such as Pietro Pieranzovini (Verdi's favorite) used either pedal drums for this opera or employed an assistant to operate the cranks or rotate the timpani, depending upon the type of machine drum.¹⁴¹

141. The question concerning what kind of timpani Verdi had in mind or the type of drums used in various Italian orchestras of that time is an interesting one that for the present remains unanswered. For example, nothing whatsoever is to be found on this subject in P. Berl, "Instrumentation der Verdi-Opern" (Ph.D. diss., Vienna, 1913). It seems logical to assume that Verdi wrote the majority of his timpani parts (especially for the middle and late operas) with machine drums in mind. Indeed, the timpanist of the Royal Opera orchestra in Milan (La Scala), Carlo Antonio Boracchi (b. 1804), worked on an improved tuning device, arriving finally (ca. 1840) at a design consisting of an armature that could be fitted over a conventional kettle. Eight vertical rods were



EXAMPLE 14. Gustav Mahler, Symphony no. 3 in D Minor (1895), first movement.

In his use of percussion, Mahler followed in the tradition of Berlioz and Wagner. However, with as many as six drums and two performers at his disposal, he was more often melodic than merely rhythmic in his handling of the instrument (ex. 13).¹⁴² In many passages, such as the opening measures of his Symphony no. 3 in D Minor (1895), Mahler shows his reliance upon machine drums for effecting the fairly rapid changes required (ex. 14).

attached to the drum's counterhoop, their lower ends bolted to the projecting arms of a base plate underneath the drum. This, in turn, moved up and down on a large, threaded central screw, to the bottom of which was attached a horizontal tuning lever. When moved to the right or left, this lever turned the screw, raising or lowering the base plate with its vertical strut assembly and thus changing the tension of the head. See Boracchi, *Manuale pel timpanista*, p. 17f. and Tobischek, *Die Pauke*, p. 155. The instrument had several major drawbacks, judging by the author's picture of his drum. The performer had either to bend way down in order to move the tuning lever by hand or else push it from side to side with his foot. The supporting metal tripod bolted to the kettle not only limited the horizontal movement of the tuning lever but restricted the drum's free vibration as well, thus adversely affecting its tone quality. As far as is known, Boracchi's timpani were never manufactured; and his invention could be safely ignored here except for the tantalizing possibility that Verdi himself might have been familiar with it through Pietro Pieranzovini, his favorite timpanist and Boracchi's successor in the La Scala orchestra. However, my inquiry to the Teatro La Scala yielded no information whatsoever. Similarly, Prof. Luigi Torrebruno (author of *Il Timpano: Technica dello strumento ad uso dei compositori, del direttori l'orchestra e degli esecutori* [Milan: G. Ricordi, 1954]) could not provide me with any data relating either to Boracchi and his machine drum or to Verdi. Obviously, by the time the composer had written *Otello*, the more demanding nature of his timpani parts required the use of machine drums of some sort.

142. See Anton Schaefers, *Gustav Mahlers Instrumentation* (Düsseldorf: Dissertationsverlag G. H. Nolte, 1935), p. 65f. Mahler wrote that "in my music the bassoon, the bass tuba, and even the timpani must be songlike" (Becker, *History of Instrumentation*, p. 30). Interestingly, during a roll on low F in the last movement of his Symphony no. 1 in D Major (following rehearsal mark no. 23), the composer's written instructions in the score direct the second timpanist to lower the note a semitone as his companion is playing. This confirms that Mahler assumed the use of a hand-cranking machine drum rather than the pedal timpani with which, of course, one performer alone could easily make the change while playing. The use of such drums in Vienna has continued to the present day.

Immer sehr lebhaft

2
ff *f* *ff*

EXAMPLE 15. Richard Strauss, *Til Eulenspiegels lustige Streiche* (1895).

Ziemlich langsam

Solo
etwas lebhafter
f *f* *f*

EXAMPLE 16. Richard Strauss, *Salome* (1905), "Dance of the Seven Veils." Copyright 1905 by Adolph Furstner; renewed 1933. Copyright and renewal assigned to Boosey & Hawkes, Inc. Reprinted by permission.

Etwas breit und wuchtig

f 1-3 1-2

[248] *p* *f* *p* *f*

[249] *ff* 3 *p*

[250] *p* *mf* *mf*

Immer fließender

251 *mf* *cresc.*

252 *f* *ff* *tr* 1-2 *ff* 1-2

253 *mf* *f* *ff* *tr* *ff*

254 *mf* *f* *ff* *ff*

255 1-2 2 3 *f* 1-2 1-2

Immer fließender

257 *f* *p* *ppp* *tr* *p*

259 *f* 3 *pp* *tr*

260 *f*

EXAMPLE 17. Richard Strauss, *Elektra* (1908). Copyright 1908 by Adolph Furstner; renewed 1935, 1936. Copyright and renewal assigned to Boosey & Hawkes, Inc. Reprinted by permission.

[66] *Molto con moto*

ff

[67]

f

[68]

ff

[69]

f mf

[70]

f

EXAMPLE 18. Richard Strauss, *Der Rosenkavalier* (1910), Waltz scene. Copyright 1909, 1911, 1912 by Adolph Furstner; renewed 1938, 1940. Copyright and renewal assigned to Boosey & Hawkes, Inc. Reprinted by permission.

Probably the most demanding and innovative composer of that time was Richard Strauss.¹⁴³ In his early *Burleske for Piano and Orchestra*, composed only four years after Pittrich's invention, he gave the opening melody to four solo timpani, whose pitches remain constant throughout the work except for a quick change from *A flat* to *B flat* (and back) for three notes which Strauss says are to be played only if machine drums (*chromatische Pauken*) are available. By the time he had written *Til Eulenspiegels lustige Streiche* (1895), the use of either pedal timpani or machine drums capable of extremely rapid tuning was absolutely essential (ex. 15). For example, in numerous places in *Salome* (1905), such as the "Dance of the Seven Veils," Strauss asked the timpanist to execute passages consisting of an unbroken succession of notes (ex. 16), and there are many other instances requiring rapid pedalling on one drum while playing on another.¹⁴⁴ His operatic scores in particular are full of such examples,

143. See esp. Richard Specht, *Richard Strauss und sein Werk*, 2 vols. (Vienna: Universal-Edition, 1921).

144. The well-known stepwise progression upwards in the timpani towards the end of the *Sinfonia domestica* is not in the original score. That "master timpanist" Hans Schnellar (who built his own instruments and had only recently produced an improved

aply demonstrating his complete reliance upon Pittrich's tuning mechanism or similar devices (exx. 17 and 18).

Thus, the nineteenth century played a crucial role in the development of the timpani. Within the space of some seventy years there were more changes in the instrument and its use than ever before or since. Composers gradually abandoned the constraining limitations of writing for two drums with more-or-less standard tuning and few changes of pitch. The use of three and four drums, sometimes with as many players, not only permitted them to expand their tonal and harmonic palettes but also encouraged them in writing parts with greater rhythmic complexity and diversity. Taking advantage of current mechanical technology and its skilled practitioners were the timpanists themselves, who, often with missionary zeal, spread the development of these new instruments by both word and deed. The inventors of machine tuning were able to realize two main advantages from the use of such devices: an enormous saving of time over hand operations and far greater accuracy.¹⁴⁵ These, in turn, gave composers the opportunity to write for the instrument in virtually unhampered fashion and provided the performer with the means to respond fully to any demands made by the music itself. At last the timpani were freed from their severe limitations and became coequal with the other instruments of the modern symphony orchestra.

IBM Corporation

White Plains, New York

machine drum with help from Prof. Biston of the Wiener Technischen Hochschule für Akustik) surprised Strauss during a performance of the work celebrating the composer's sixtieth birthday by playing this scale along with the rest of the orchestra. This display of virtuosity persuaded Strauss to incorporate these additional notes into his own copy of the score, and it has since become common practice to include the interpolation. (Performing this scale with a hand crank is not as difficult as it might seem: one hand plays the notes while the other rotates the handle—in the case of the Viennese instruments approximately one-eighth of a turn for each successive note.) My thanks for this information to Prof. Hochrainer, a pupil of Schnellar, and to Wolfgang Schuster of the Wiener Schlaginstrumentenbau.

145. Coincidentally, these are among a dozen overall advantages resulting from the use of machinery cited by Charles Babbage, "On the General Principles Which Regulate the Application of Machinery to Manufactures and the Mechanical Arts," in *The Encyclopaedia of Arts, Manufactures and Machinery*, ed. Peter Barlow (London: J. J. Griffin and Co., 1851), pp. 8–12.